

---

# DESIGN FOR DEMENTIA

---

GREGOR TIMLIN AND NIC RYSENBRY

---

# DESIGN FOR DEMENTIA

---

IMPROVING DINING AND BEDROOM  
ENVIRONMENTS IN CARE HOMES

GREGOR TIMLIN AND NIC RYSENBRY

# CONTENTS

---

Foreword by Clive Bowman	4
Executive Summary	6
<b>Context</b>	11
What is Dementia?	13
The Challenge for Care	18
Design Goals	20
Research Methods	26
<b>Dining</b>	31
Dining and Care	33
Interior Layout	37
Tableware	49
<b>Bedroom</b>	65
The Bedroom and Care	67
Personalisation	71
Dressing	79
<b>Conclusion</b>	91
Conclusion	92
Selected References	93
About the Authors	94
Partner Description	95

---

# FOREWORD

---

Dr Clive Bowman FRCP FFPH  
Medical Director, Bupa Care Services

In an ageing society, the provision of quality residential care services for older people with dementia is rapidly becoming one of the great challenges of the age. At Bupa Care Homes, we are rising to this challenge by continually reviewing and enhancing every aspect of the care we provide – clinical, technological, social, environmental and personal.

As international providers of 35,000 care home beds, principally in the UK but also in Spain, New Zealand and Australia, we have long recognised that design plays a very significant role in the quality of life that people experience in the care home. However, while much has been done to develop guidance and insights related to design for older people per-se, there has been far less practice-based research carried out into the specific needs of people with dementia and the staff who support them.

Cognitive decline brings with it a whole host of seemingly intractable difficulties for the designers of care home products and environment. While medical research looks at the causes of dementia, design research must deal with the effects. The research project described in this publication is therefore both timely and welcome because it adds to our knowledge in an underexplored aspect of the care and support of people with dementia.

Over the past two years Bupa has worked closely with two product designers based in the Helen Hamlyn Centre at the Royal College of Art, one of the world's leading art and design schools. As Bupa research associates, Gregor Timlin and Nic Rysenbry have engaged closely with and across our organisation, and looked afresh at some key issues of residential dementia care through a design lens.

What they have produced is a measured analysis of how better design can improve dining and bedroom environments for people with dementia – and a series of prototype designs and exemplar layouts that express a valuable people-centred approach. This publication is not an exhaustive analysis of design for dementia in all its aspects, but aims to encourage critical reflection on key areas by designers, specifiers and managers.

One of the most positive aspects of working with the Helen Hamlyn Centre at the RCA is that it has an ethos of ensuring that its designers operate as social researchers, so that there is a seamless transfer from ethnographic study to practical design intervention. Instead of remaining in the ivory tower of the design studio, the two research associates really spent time in Bupa care homes working with residents, carers, families and managers to understand the underlying dynamics of dementia care. I thank them for their sensitive engagement and our staff and residents who have so richly informed them.

Bupa is grateful to the authors of this publication and to Professor Jeremy Myerson, Rama Gheerawo and Ed Matthews in the Helen Hamlyn Centre for their commitment to making the collaboration work. We have encountered a refreshingly open research approach compared with that more typically encountered in medical research and have learnt much from its well-crafted focus on the individual and design challenge.

## EXECUTIVE SUMMARY

### Overview

This publication describes a two-year collaborative research project between the Helen Hamlyn Centre at the Royal College of Art and Bupa. It explores how better product and environmental design can improve quality of life for care home residents with dementia.

*Design for Dementia* is aimed at care providers, manufacturers and designers with an interest in improving existing care homes. The design ideas and principles that have been developed are a practical response to challenge of cognitive decline and can be retrofitted to existing care homes as well as applied to new developments.

It is not the intention of the authors to propose expensive refurbishment or a complete overhaul of the care home environment in every case; simple, common sense applications of design thinking can create big improvements with relatively small investment.

### Context

The book begins by setting the context of the specific challenges that dementia can present before going on to outline design guidance through two case studies of dining and bedroom environments. It looks at the design implications of early, mid and late stages of dementia, recognising that dementia progress slowly and changes over time.

The vast majority of care home residents in the UK have a form of dementia. More than a third of these residents are not staying in facilities specifically designed for their needs. Many homes have been adapting existing environments that are not up to date with current thinking in the field. As a result, poor care facilities are making it more difficult for carers to deliver a good level of person-centered care, provide appropriate activities and empower residents to optimise their existing ability.

### Methods

In recognition of the difficulties of studying people affected by cognitive decline, an immersive research method was adopted. This allowed the researchers to become part of the everyday routine in several care homes where they interviewed and observed residents and staff. Focus groups were held with people in the early stages of dementia. Two ideas were important: first, to allow residents with dementia to express themselves; and second, to see them as real people with real lives.

### Design Strategy

A design strategy was developed to create proposals for facilities and products which enhance residents' abilities in three key areas:

**Cognitive Ability** is improved by promoting the use of familiar and recognisable surroundings and activities that respond to residents' deepest and earliest memories.

**Social Ability** is addressed through the design of artefacts and amenities that create opportunities for residents and staff to interact more easily in activities of daily living.

**Physical Ability** is promoted through design which unobtrusively compensates for disabilities such as mobility and vision which are prevalent among care home residents.

These values have been exemplified in two case studies that explore concepts and prototypes for dining areas and Bedrooms.

### Dining

The dining section explores how to improve dining culture and rituals without changing existing food service infrastructure. The following practical design changes are proposed:

**Interior layouts** that reduce visual and physical barriers for residents, allowing for more safe and unrestricted movement throughout dining areas and the care home.

**Design of amenities** which capitalise on redundant space and integrate activities such as cooking and gardening into existing spaces.

**New lighting and furniture design** which allow for greater physical access for those with poor visual acuity and mobility problems, including a wheelchair accessible table and dimmable overhead light.

**New tableware** designed to promote independent eating and improve the experience of being fed for those who are no longer able to feed themselves.

## Bedroom

–  
The bedroom is the one place in the care home that can reinforce personal identity and act as a place of refuge. The bedroom section focuses on the importance of personalising private space and on enabling residents to retain independence and the ability to dress themselves for as long as possible. Here, the following practical design changes are proposed:

**New personalisation system** based on adapting hook-and-rail display techniques from the retail sector for swift, easy, low cost customisation of a care bedroom with objects, pictures and shelving.

**Redesign of bedroom entrances** to more clearly express the transition from communal to private space and to reinforce the identity of the occupant.

**New wardrobe and dresser designs** that respond to the individual needs of care home residents by using such features as contrasting colours and materials, over-sized handles, content-visible drawers and whole-outfit hangers to assist dressing.

---

# SECTION 1. CONTEXT

---

---



Residents seated in lounge

## WHAT IS DEMENTIA?

Dementia is an umbrella term used to describe the symptoms that occur when the brain is affected by a number of conditions, most commonly Alzheimer's. Symptoms of dementia include loss of memory, mood changes and communication problems and people affected will typically experience a decline in the ability to talk, read and write.

Dementia is progressive, meaning that the symptoms will gradually get worse. A person in the later stages of dementia will have problems carrying out everyday tasks of daily living and will become increasingly dependent on other people.

In care homes, staff training and well-designed physical surroundings are important. They offer a framework for people with dementia to maintain their existing skills, create opportunities for meaningful engagement between residents and staff and greatly affect quality of life.

### WHY DESIGN FOR DEMENTIA IS IMPORTANT

Two-thirds of the population of care home residents in the UK have a cognitive impairment.<sup>1</sup> Dementia is the strongest determinant of entry into residential care for people aged over 65.<sup>2</sup> These figures are likely to rise as the population ages thereby creating more demand for facilities and as new drugs are introduced to slow but not cure the progression of the disease.

The quality of dementia care in the UK varies, ranging from excellent, through mediocre to neglectful. Only 60% of individuals in care are currently staying in dementia registered beds specifically geared towards their high level of needs. Reports from organisations such as the Alzheimer's Society suggest that many homes are not providing an appropriate level of person-centred care. Problem areas including the provision of activities, the treatment of residents with dignity and respect, and the relationship between homes, relatives and friends.

A key issue in improving care is to better understand how the design of care home environments impacts on the quality of care. Features, layouts and facilities can help to maintain a resident's remaining strengths, improve working conditions and provide a better care culture for staff, residents and visitors alike. This publication explores the role design can play in improving care homes, presents an understanding of residents' needs and gives a design perspective on dementia.

—  
1.,2. Samantha Sharp,  
Home from Home: A Report  
Highlighting Opportunities  
for Improving Standards  
of Dementia Care in Care  
Homes, Alzheimer's  
Society, 2007, p4

## THE THREE STAGES OF DEMENTIA

The most important thing for any designer working in dementia care is to recognise that dementia is a disability and any solutions they design need to offset the effects of the condition. Understanding the degenerative nature of dementia and designing to compensate for its effects become critical in meeting the challenges.

There are different types of dementia, but all have a similar effect on the person with the condition. This section primarily focuses on Alzheimer's as it is the most common form of dementia by far. In most instances, the progression of dementia is slow and consistently changes over time. For the purposes of this publication, this process has been simplified into three stages namely early, mid and late.

### Early

–

In the early stages of dementia, a person will slowly develop changes in their abilities and behaviour. They may not be vocal about problems and will often cover up gaps or lapses in memory. As these can be also attributed to other factors such as stress, bereavement or the natural process of ageing, onset of dementia can be difficult to pinpoint. Very often, it is only diagnosed retrospectively and recognition that someone is in the early stages of dementia is difficult and rare.

An early indicator is difficulty in remembering recent events. People may forget conversations that have recently happened or can become slower at grasping new ideas. Recurring confusion can be another sign but symptoms can be so subtle that they might be limited to occasional lapses that only a close friend, companion or relative might notice.

Care for a person at this stage should be supportive to allow them to retain their independence. It is critical that a carer does not take over tasks completely as this may undermine a person's confidence and their notions of self-worth. A person may experience distress over not being able to complete tasks they could easily accomplish previously. A good practice is to offer reassurance and support. People can also use memory aids to support themselves such as taking notes or using written calendars to remind them of events.

### Mid

–

In the mid stages of dementia, memory lapses and confusion become more obvious and a person can no longer hide it from those around them. Short-term memory becomes impaired and they will often ask many repetitive questions. They may be anxious about when events are happening, become more forgetful and develop difficulties in finding words or remembering names. It is common that they will fail to recognise other people or confuse someone known to them with someone else.

A substantial challenge will be the difficulty they experience in managing everyday life. They may need frequent reminders about activities or how to complete basic tasks. Gradually, the tasks of daily living will begin to become more difficult and they may need help or encouragement with eating, dressing or going to the toilet.

A person may become more socially withdrawn or less comfortable in group situations. In some cases they may also become more socially isolated as friends and family members no longer relate to the person in the same way as they once did and visit less often as a result.

Other difficulties include awareness of their environment. They can often become confused about where they are and wander off and become lost even if they are in familiar surroundings. In some situations this can present a risk to the person themselves and those around them, such as forgetting to light the gas on a stove, trying to drive or leaving an iron on.

The level of care a person needs at this stage increases. Those close to a person have to be vigilant, assessing tasks that the person may no longer be able to complete independently and assisting them where necessary. Activities such as shopping, cooking or anything else that requires a sequence to be completed will become more challenging. Those still living at home will require regular visits to ensure they are eating well, taking their medication and not at risk. Opportunities to connect socially with others will be important. Discussing the options of moving to a care home or increasing the level of daily assistance within their own home will become necessary during this stage.

### Late

–

In the late stages of dementia a person will ultimately become dependent on other people for nursing care. Memory loss extends to older memories and a person may not be able to determine the function of familiar objects or recognise people who are close to them. There is a gradual and increased loss of speech. People are often restless and they can have a tendency to want to search for someone or something. A common occurrence is the desire to be with their mother or in their own home, even if that is where they are being cared for.

Some people can have less control of their emotions and become aggressive particularly if they feel threatened. It is common for a person to become increasingly immobile often starting to shuffle when they walk or becoming more unsteady on their feet. Many people can end up being bed bound or confined to a wheelchair. Some of the most challenging problems that can arise include the development of a swallowing problem or incontinence.

Care requirements of a person in the late stages of dementia dramatically increase. A person will need daily, if not full time supervision. Dementia will limit their ability to communicate verbally and they will need high levels of assistance with activities such as bathing and dressing, which can no longer be carried out independently.

When levels of assistance increase it is imperative that the person is constantly reminded of who they are and consulted about what they are doing to lessen the feeling that they have no control over the situation. On occasion, individuals might have an angry outburst during an intimate care task. This is a very natural reaction especially if they do not remember or recognise the carer who might appear as a stranger to them.

Despite a person no longer being able to communicate verbally it is still possible to share significant experiences and to communicate using other methods. Holding someone's hand, a smile, the scent of a freshly baked scone, the sound of a loving voice or the feel of an animal's fur can all communicate where words fail. Carers need to be highly resourceful and know a great deal about the person they are caring for in order to find things they can still enjoy and be engaged in.

People will experience good and bad days. There can be moments of real clarity and others where they exhibit severe agitation and annoyance. It is important to share and enjoy the good moments and help a person through the difficult ones. As dementia is prevalent in old age, many people will die in the care of others and in the late stages of dementia. Creating avenues for people to communicate and activities that they can engage in as dementia progresses becomes an important challenge for designers within the care environment.

—  
Opposite:  
Diagram illustrating  
the three progressive  
stages of dementia

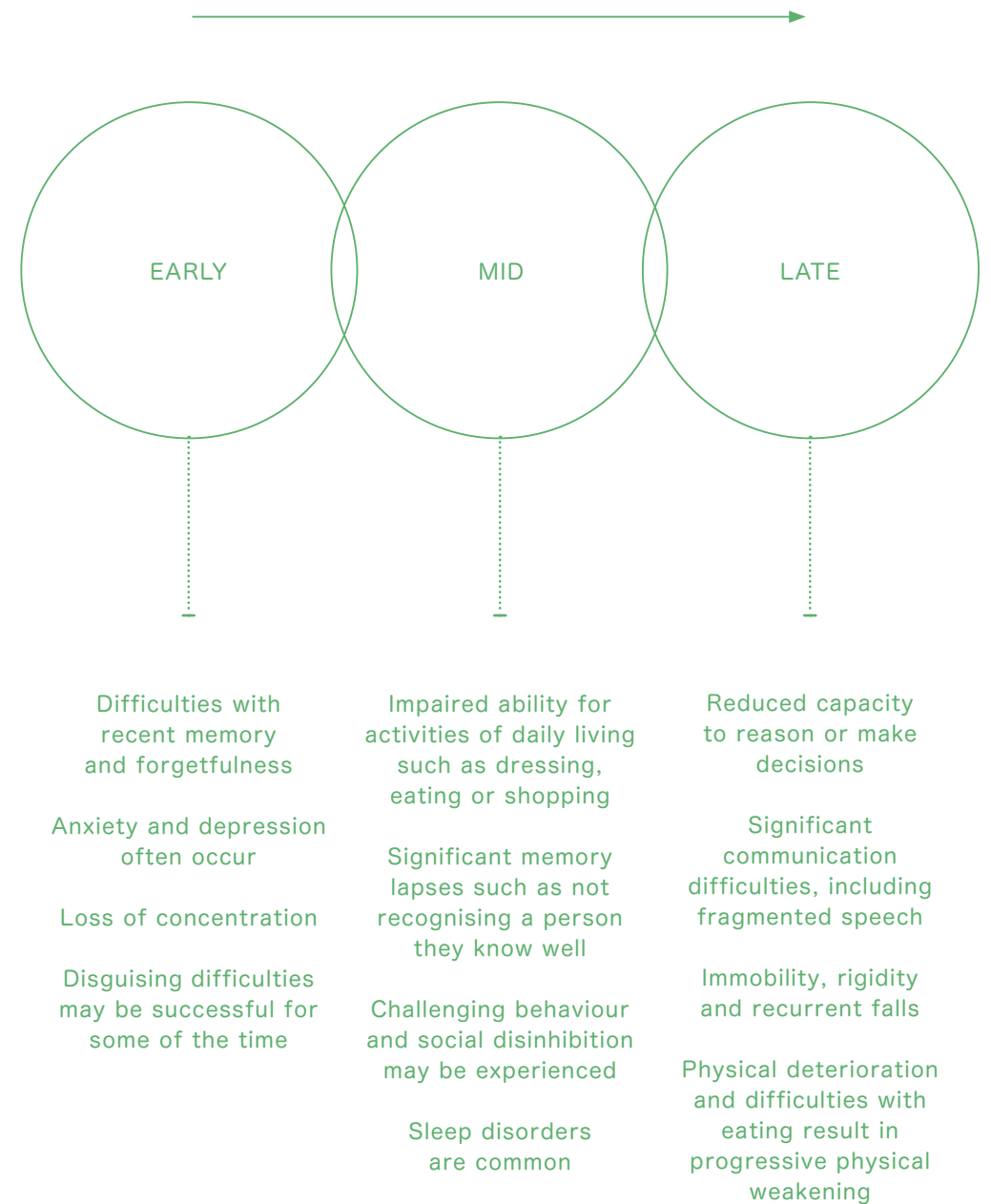

## THE CHALLENGE FOR CARE

The reason that a person might be admitted to a care home is not exclusively related to dementia. People enter care for a variety of reasons. These can be socially-related such as not having someone who is able to look after them at home, or they can be financial, as in not having enough money to pay for home care. On occasion they may be totally unrelated to dementia if, for example, a person has extreme physical difficulties such as a mobility problem. The reality is that care homes cater for a diverse clientele.

In any given home there can be people ranging in age from their 60's to their 90's. Residents can be physically strong yet in the late stages of dementia or extremely weak and yet cognitively alert. They can be able to care for themselves or closer to palliative care and therefore highly dependent on staff for almost every task of daily living such as needing to be fed at all mealtimes. This puts pressure on care homes to provide a range of ability-appropriate activities for residents and creates an onus on having facilities that cater for all the needs of this diverse group.

One of the major challenges of care is managing staff stress, especially those working with residents who have dementia. In a good care facility, staff-to-resident ratios can be as low as one to four. The job often involves long hours and is poorly paid. Turnover of staff in care homes has been reported to be as high as 30% over nine months in struggling homes.<sup>3</sup> Training in how to specifically manage and support residents with dementia is often lacking.

As the job is challenging, staff can have little time to interact with residents. This can be damaging to the quality of life of someone with dementia as they often need personal attention. A recent Alzheimer's Society report found that the average person in care interacted with a staff member in an activity not related to a care task for as little as two minutes every six hours.<sup>4</sup>

A 2005 report calculated percentages of people in care home at the different stages of dementia. Figures indicate that 23% are in the early stages, 32% in the mid stages and 45% in the late stages.<sup>5</sup> This means that just over half are in early to mid stages and therefore still capable of performing many self-care tasks under their own initiative. It is important that this group is enabled to live to their full potential and that their independence, where possible, is promoted.

However, the design of many care homes does not allow this to happen. In some cases, the environment can actually add to the existing disabilities of residents and increase the level assistance needed from staff. Problems as basic as steps instead of flat surfaces, confusing layouts

–  
3. Margallo-Lana, M., Reichelt, K., Hayes, P., Longitudinal Comparisons of Depression, Coping and Turnover among NHS and Private Sector Caring for Older People with Dementia, BMJ, 2001, p769 - 770

–  
4. Samantha Sharp, Home from Home: A Report Highlighting Opportunities for Improving Standards of Dementia Care in Care Homes, Alzheimer's Society, 2007, p14

–  
5. Darton, R., Forder, J., Beddington, A., Analysis to Support the Development of the Relative Formula for Older People: Final Report, PSSRU, Discussion Paper, University of Kent, p2265

which prevent residents from finding their way or no access to outdoor spaces all turn actions that could be completed by residents independently into obstacles that staff have to help them overcome.

One major goal of this project has been to develop better design strategies that help to promote resident independence and improve carer and resident interaction. By improving a resident's ability to be more self-sufficient, staff time is freed up, giving them more opportunity to engage with residents at a social and personal level. This, in turn, improves quality of life for residents and can make the job for staff more enjoyable and less stressful.

Independence for residents

=

More staff free time

=

Improved social interaction

## DESIGN GOALS

Design in care homes needs to focus on three key areas. It should:

1. Address the cognitive difficulties people experience as a result of dementia by creating environments and products that build on the remaining strengths and abilities that residents have.
2. Create a social environment that allows residents and staff to participate and complete care tasks together.
3. Provide a physical environment that accounts for the multiple changes that care home residents will experience as a natural part of the ageing process.

This section of the publication outlines these core principles. The following sections look at how these principles can be applied to design case studies that demonstrate how existing care home environments can be improved.

### COGNITIVE

A key aspect of designing for a cognitive impairment like dementia is to build on the strengths that residents still have. Design should not just aim to support their disabilities, but utilise their remaining abilities. There are a number of ways in which this can be done.

#### Recollection 'vs' Recognition

A person with dementia will find it easier to remember a fact or procedure when they are prompted by a reminder or a memory aid. This is generally termed recollection. What becomes more difficult is recalling information without a leading link, such as trying to recall what clothes a person wore yesterday. This is called recognition. Utilising the power of recollection has many applications in dementia care.

The building layout of the care home should be based around significant places that are held within a person's oldest and strongest memories. New environments that use unfamiliar typologies will not help a person to recollect the purpose of that space or how they should interact with it. Rooms which include recognisable objects such as dining tables in a dining room will be more identifiable from a person's past. They will appeal to a person's earlier memories and in most cases evoke positive and useful associations.

—  
Opposite:  
An outline of the design  
strategy aimed at  
addressing various  
aspects of dementia  
in care homes

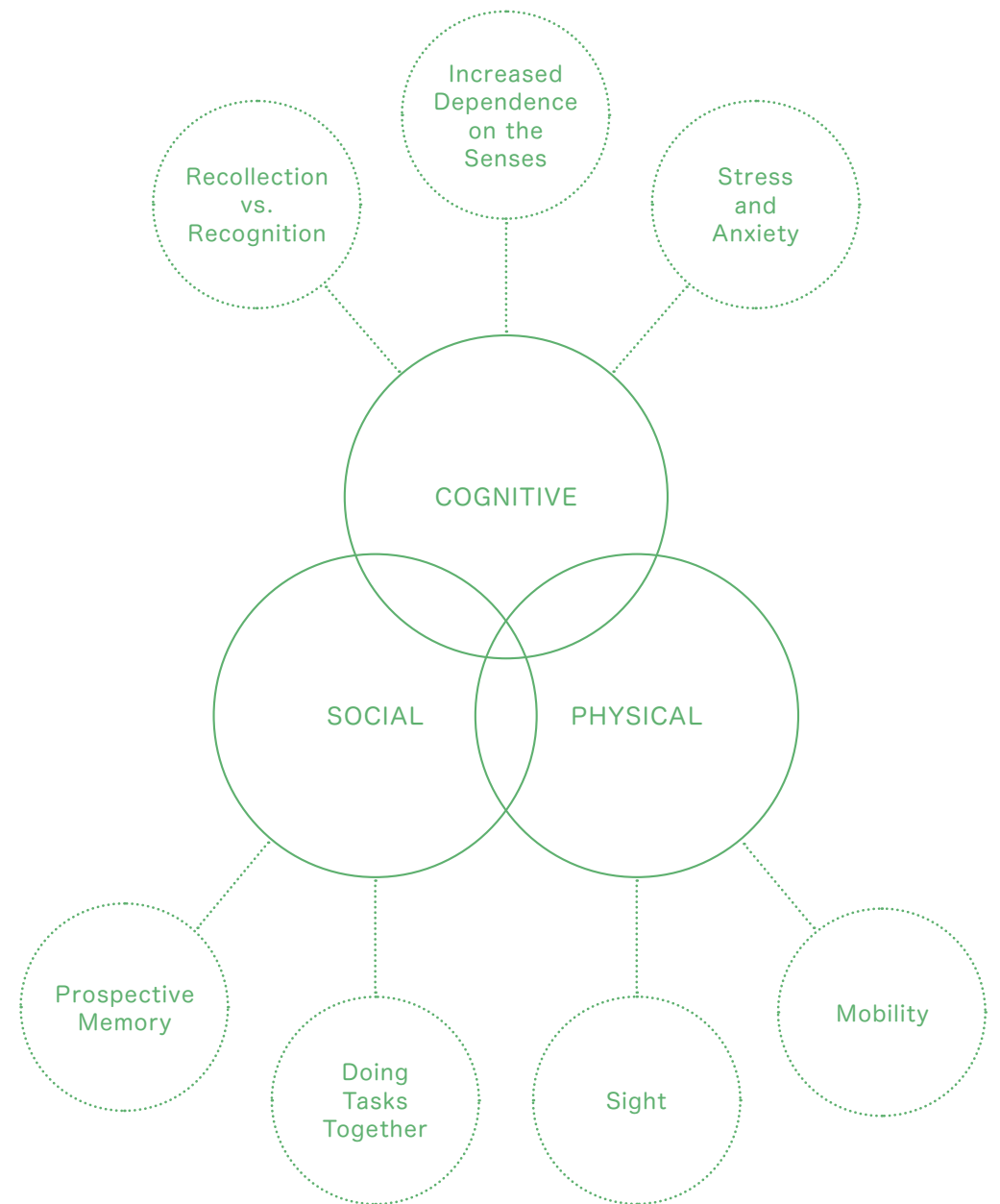

People with dementia find it difficult to remember visual maps of a building even if they have been living in it for some time. Wayfinding skills can be improved by ensuring each room is distinctive in its décor so that it is visibly different when a person is navigating the home. Each room should have one activity associated with it so that a person can develop a familiarity with its purpose over time. Information needs to be embedded in an environment rather than having to be kept in mind.<sup>6</sup>

Recollection can also be applied to something as basic as including a relative's name with their picture to help a resident remember a family member when they come to visit.

### Increased Dependence on the Senses

Increased dependence on the senses is as common in people with dementia as with other disabilities. It can be a challenge to understand which senses are working most effectively as this will differ for each individual.<sup>7</sup> Different senses need to be used in the design of products and environments so that people do not have to rely on only one sense.

It is essential to ensure that environmental cues give good information to a resident about where they are and what activity is taking place. This will help to adjust behaviour accordingly. There are numerous ways in which this can be employed but some examples would include using a person's possessions to decorate a private bedroom, being surrounded by familiar sounds and artefacts such as the ticking of a familiar clock, the smell of a particular perfume or the sound of a favourite piece of music. All of these use different senses to help a person identify and feel comfortable in a particular space.

### Stress and Anxiety

High levels of stress and anxiety can be common for people with dementia and can impair their ability to function. Good dementia care includes reducing stress triggers, and measures such as protected meal times where residents are not allowed to be disturbed by anyone whilst eating, have proved to be very successful.

Not all rooms need to be quiet and calm but it is important to be able to control stimuli so that environments can be tailored to the needs of individual residents. A room that includes the noise of a television, people moving through the space or that is too crowded can result in overstimulation and stress. People with dementia may not be able to process or block out multiple forms of conflicting information so the layout of a room needs to be thoroughly considered to ensure stimuli are appropriate, clear and controllable.

## SOCIAL

Environments should create opportunities for a good level of social interaction between staff and residents. This is important for both the well being of the residents and the job satisfaction of the staff.

### Prospective Memory

Memory is not just about remembering what has happened but also about remembering what will happen. Prospective memory or planning memory is about remembering and maintaining future aims as well as recalling what is needed to reach that aim.

For people with dementia, the ability to remember future events is lessened. It has been suggested that this is one of the reasons why people may seldom do things under their own initiative.<sup>8</sup> Opportunities must be provided to keep people active and socially engaged and ensure that they do not become apathetic or depressed.

### Doing Tasks Together

With dementia, performing tasks that require a lot of steps can be very difficult as this involves a complex process termed 'executive functioning'. In a task such as dressing, a person will have to plan what they intend to wear, initiate the process of putting on clothes, monitor that they are putting them on in the correct order, perhaps take corrective action and finally verify they have completed what they started. Tasks that require sequences of information become more incomprehensible from the mid stages of dementia onwards.

Although it is impossible to restore a person's ability to do such tasks independently, once that ability has been lost carers can take the time to remind them of sequences they have forgotten. This allows people to re-access activities and reconnect with them.

Procedural memory is retained for longer and should be seen as a strength that can be built upon. This is the memory of how to do things without having to think. People can continue to carry out tasks that have become more or less automatic. These skills are will vary from person to person but a good place to start is with everyday activities that most people will have carried out all their lives.

As well as providing opportunities for residents to function on their own, design should enable residents and staff to do things together. Simple activities such as helping to set the table, watering plants in the garden or helping to peel potatoes can offer a space for staff and residents to work together and build more meaningful relationships.

6. John Zeisel, Environmental Neuroscience and Alzheimer's Disease. In *Alzheimer's Care Quarterly*, October-December 2005, p5

7. Mary Marshall, *Food Glorious Food; Perspectives on Food and Dementia*, Hawker Publications, 2003, p12

8. Grethe Berg, *The Importance of Food and Mealtimes in Dementia Care*, Athenaeum Press, Great Britain, 2002, p26.

## PHYSICAL

Physical problems such as frailty, reduced mobility and significant loss of vision are common among older people living in care. Dementia can also create a lack of awareness of a person's own physical disabilities which means that people are more at risk from causing accidents to themselves. An example of this is a resident forgetting that they may need their walking stick to safely travel down the corridor. For this reason, environments should include features that naturally compensate for physical disabilities. It is important to ensure residents are safe, empowered to use their remaining strengths and free to employ their natural sense of self-control and independence.<sup>9</sup> Two key areas that design can immediately influence are sight and mobility.

### Sight

As many as one in eight people over the age of 75 have a high degree of visual impairment with figures rising as people get older. The main causes include problems such as AMD, refractive error, cataracts, glaucoma or other issues such as severe short sightedness.<sup>10</sup> As people grow older, the thickening and yellowing of the lens and the decreased pupil size lead many older people to need three times as much light as that of a younger person to easily perform activities such as reading.<sup>11</sup> There also are reports that Alzheimer's has a direct effect on the visual system of the brain creating difficulty with depth of perception, spatial orientation and judging colour contrast.<sup>12</sup>

Eye care brings added difficulties for people with dementia. These include basic problems such as individuals forgetting to wear spectacles, difficulty in communicating with optometrists in order to get successful prescriptive lenses or avoiding corrective surgery due to the vulnerability and stress involved in being transferred to a hospital environment.<sup>13</sup>

Two key solutions for people with poor vision include ensuring that there are adequate lighting levels throughout the home and that colour contrast is applied appropriately so that residents can distinguish items such as door handles and light switches. Colour can also be used to disguise facilities that may pose a danger to residents. A common trick is to paint service area doors the same colour as the wall so that residents are less likely to see and enter the space.

### Mobility

It is estimated that about one quarter of the population over 75 have some difficulty in walking.<sup>14</sup> As falls are one of the leading causes of admission to care homes, this population includes large numbers of people with poor mobility. Impaired cognition can cause additional mobility issues such as poor attention, slow processing and decreased judgment, all of which increase the risk of losing balance. Lack of awareness of environmental hazards can also contribute to mobility difficulties.

A fall can be a traumatic experience, can lead to reduced confidence, admission to hospital and increased chance of a repeat accident. Many types of dementia will gradually affect the areas of the brain responsible for balance and motor control as they progress.

Every space within a care home should support people with mobility difficulties and allow for wheelchair and walking frame access to ensure that residents are not excluded on the basis of their disability. Simple design solutions include tables that allow wheelchairs to fit under them, corridors that include rails to allow residents to support themselves as they walk and wardrobes that are at heights that prevent people having to stoop.

Residents should be encouraged to keep active and to exercise as much as possible. This strengthens muscles and maintains joints and balance. Exercise can also, in turn, help maintain mental faculties and improve awareness.

9. John Zeisel, Environmental Neuroscience and Alzheimer's Disease, Alzheimer's Care Quarterly, October – December, 2005, p6

10. Dr Jennifer Evans, Mr Richard Wormald and Dr Liam Smeeth, Research Findings Nov 05 no. 10, Thomas Pocklington Trust, p1

11. Jennifer A Brush, Margaret P. Calkins Design for Dining, Building ideas, Lippincott Williams & Wilkins, 2003, p75

12. Rizzo M, Anderson SW, Dawson J, Nawrot M., Vision and Cognition in Alzheimer's Disease, Neuropsychologia, 2000, p1157 - 1169.

13. Professor Astrid Fletcher and Dr Jennifer Evans, Research Findings May 09 no. 19, Thomas Pocklington Trust, p3

14. Caregiving; Helping the Elderly with Activity Limitations, National Academy on an Ageing Society, 2000, p2

## RESEARCH METHODS

A major challenge for this study was to create research methods that were appropriate for people with dementia. These had to be sensitive to their needs and respectful of them as individuals. Conducting ethnographic research with any group deemed to be vulnerable can be difficult, but working with people with dementia is particularly challenging as the mental condition of the person participating in the research is affected.

Two ideas became important. Firstly to find ways to engage with residents with dementia and allow them to express themselves and their opinions. Secondly, to see them not as test subjects for research but as real people with real lives. The research methods draw on processes already established within people centred design, but one tailored to the care home environment and the effects of dementia. The goal was to gather and collate existing knowledge in the field, cross reference this with findings from research with users and translate the results into design criteria and solutions for dining room and bedroom design.

Central to the study has been the participation of people with dementia in the research. Care home residents with dementia are the real experts on what they want and expect and as the people who are actually living through the experience, they are best placed to provide critical insight into what can be improved.

Research was completed in three stages:

1. Creating a basic understanding of dementia and its effects on older people in care. Beginning with desk research such as literature reviews of care practice, seminars on topics related to the research, including the UK dementia congress were attended, as were induction sessions for new staff in care homes to experience the training programme firsthand. Two focus groups involving 14 people in the early and mid stages of dementia outlined key concerns and failings, as well as opportunities for further investigation.
2. Establishing the current challenges faced by both residents and care workers in UK care homes. 18 day visits to care facilities took place in environments ranging from family homes to larger, long stay care institutions. A variety of techniques were used to gather insights including observation, photographic ethnography and informal interviews with residents and staff. This enabled a range of data to be captured. Observation allowed events to unfold and be recorded in a natural, everyday setting with no interference from the investigators, and interviews gave a more in-depth view of particular issues.
3. Development and testing of design concepts. Once insights were gathered and organised into design briefs, various concepts were developed and tested. The most promising ideas were taken forward as physical models and then finalised as exemplar designs.

—  
Opposite:  
breakdown  
of the  
research  
methods  
and design  
process

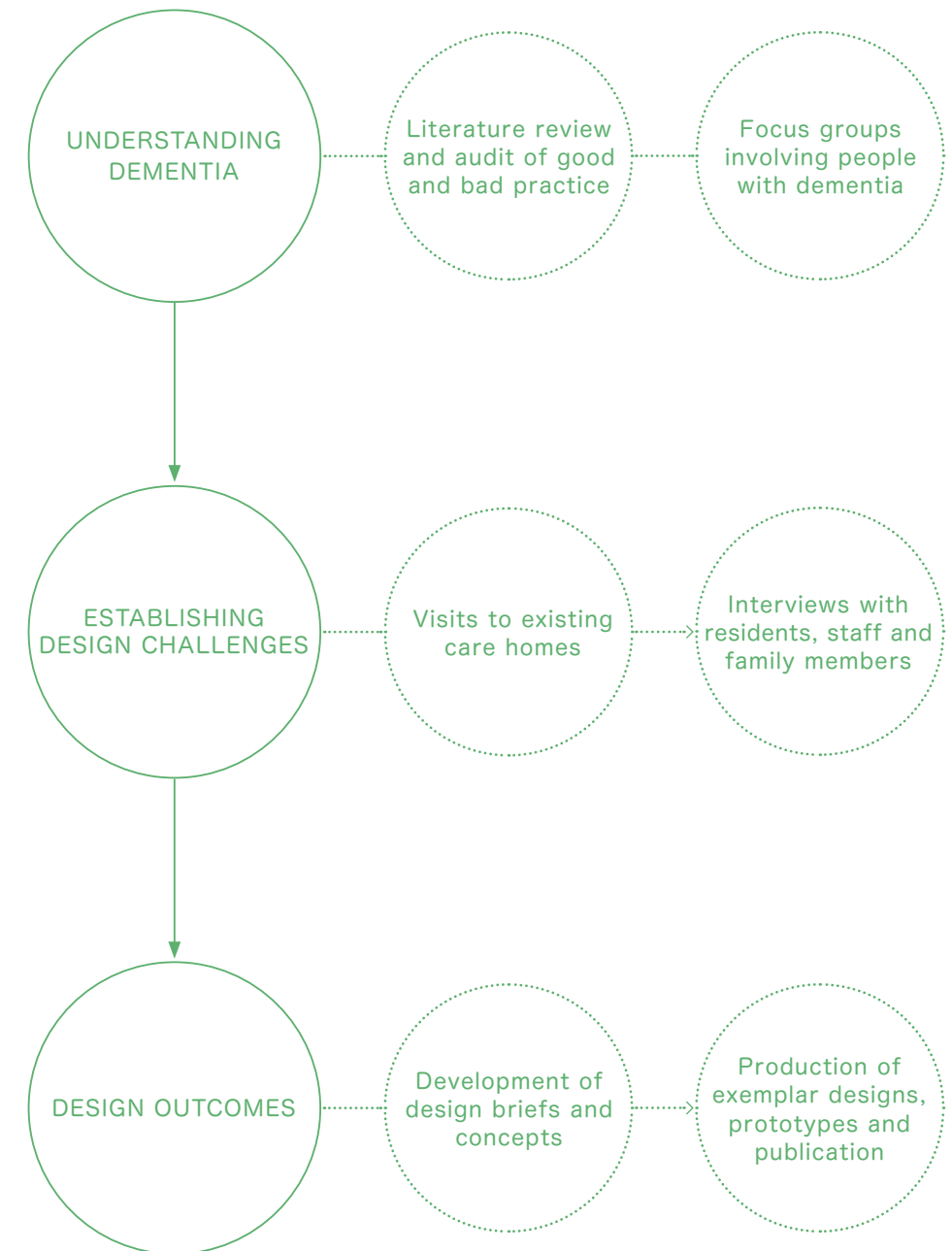



---

## SECTION 2. DINING

---

---



Centralised kitchen set aside from residential area

## DINING AND CARE:

When food is prepared in an institutional context, the expectations are typically very low. Food in a hospital or college canteen has to be quick to prepare and cheap to buy. There is no involvement in the experience of preparing or serving food other than to choose it from a menu and to briefly thank the stranger who comes to clear the table. Design in this situation is orientated towards efficiency and service, which is appropriate in situations that caters almost exclusively for one-off customers.

However, this type of food management system should not be applied to a care home where long-term residents live in the building and see it as their home. The design of the food service and dining environment directly impact a person's quality of life and the cultural and social aspects of eating. Food service should have more purpose and not just be seen as a process.

### CARE AND FOOD CULTURE

A real challenge when caring for people with dementia is to balance nutritional needs with the cultural enjoyment that food can bring. A person with dementia can have a poor appetite or lose interest in food. This can result in weight loss, reduced ability to fight infections, apathy and impaired levels of concentration.<sup>1</sup> As food and good nutrition is essential for health, ensuring that residents eat enough often overrides other considerations.

Mealtimes are a busy time of the day for staff. People with dementia can often take longer to eat, have trouble with co-ordination and in some cases have difficulty swallowing. Residents can require help to be fed or are bed-bound and need food to be brought to them. It was observed that the activity of feeding another person can often take up to 40 minutes per resident to ensure the experience is a calm and enjoyable one. Some residents may need cues to trigger appetite and help them eat. For example, staff may need to eat with them to act as exemplar eaters or use gentle verbal reminders to help them concentrate on their meal. As staff-to-resident ratios are very low in many homes, care workers report that meal times can be one of the most stressful parts of their day.<sup>2</sup>

Due to these challenges, residents are rarely encouraged to get involved in preparing meals. Part of this is to do with the structure and layout of homes and the lack of facilities for running food-related activities. Food is often prepared in a central kitchen set aside from the residential area. It is transported to separate serving units within each section and then distributed. Service areas only include basic amenities for washing and serving and residents are not allowed into these areas for reasons of health and safety.

–  
1. Report of an Expert Working Group, Eating Well for Older People, The Caroline Walker Trust, 1995, p22

–  
2. Philips LR, Van Ort S. Measurement of Mealtime Interactions among Persons with Dementing Disorders, Journal of Nursing Measurement, 1993, p41-55

In addition to creating a very institutional feel, this type of design creates a culture that does not allow the residents to get involved in the rituals surrounding food. In the homes that were visited, there were instances where residents were observed trying to help with the meal service but were prevented from doing so. In one example an older lady was reprimanded for bringing her dishes back to the service area so they could be washed. On remarking that she was only trying to help, a member of staff told her to sit back down in case she fell. The focus in this home was on health and safety and the chance to contribute was taken away even though most were still capable of helping.

### The Social Significance of a Meal

One of the strengths of people with dementia is that they have a lifetime of memories that can be accessed and enjoyed if they are presented with opportunities to share them. Food can provide meaningful memories that are associated with positive values and good experiences.

Rituals such as Sunday dinner use food to bring the family together, not just to eat but to share in each other's lives and offer support. Celebrations for birthdays, new jobs or exam results are all opportunities to have a meal with colleagues, friends or family. Even the quality of an everyday meal can change depending on whether it is shared with someone or eaten alone.

For many people from the generation currently living in care, mealtimes reinforced their role within family and society. Throughout their lives, the ritual of the family meal was more than just a daily task. As a parent it gave them a chance to fulfill their responsibility as nurturer and as a child it gave them the feeling that they were being looked after. The meal was an important staging post in the day with allocated roles and responsibilities for all concerned.

The act of preparing a meal for other people has real social significance and is seen in most cultures around the world as a personal gesture of friendship and companionship. Even when eating out, the ability to invite and pay for guests in a restaurant gives the organiser a sense of social status. The need for people to feel that they are a part of a community and engage in food culture does not go away because they enter a care home. For people with dementia, older and deeper memories last longest and this offers tremendous potential for creating a socially inclusive dining experience.

### What People with Dementia Say They Want

During workshops conducted in the research phase of the project there was real resistance to the idea of going into care. People feared that a care home was a place that would take away their right to an independent life.

When asked about their aspirations surrounding meals, a recurring theme was freedom of choice. People did not want to be part of a set routine and wished to have choice in what they ate and when they ate it. They desired a socially supportive atmosphere with opportunities for engagement with other people. Ideally, they wanted to be able to maintain their current interests in food and have new experiences.

In the better homes that were visited, food was treated in a more culturally significant way. A baking group at one care home there was an atmosphere more akin to a family kitchen than an institution. Residents worked alongside staff and had a sense of purpose and position of value. They were utilising their existing skills and were viewed by staff not as people who needed support but as individuals with something to offer. It was evident that residents were enjoying themselves and staff were more satisfied to see the people in their care achieving their full potential.

### GOALS AND AIMS

In this section, existing nursing home architectures that typify practice have been taken as a starting point and new design ideas explored to provide a more vibrant food culture for both staff and residents. Infrastructure for staff to run activities in cooking or growing food have also been looked at. Ideas are suggested to help residents retain their physical and cognitive strength and remain as independent as possible.

The focus is on simple low cost modifications such as basic renovation, and product design that can be added without architectural alteration. The ideas that have been developed are not the results of a theoretical exercise, but can be practically applied today and work in line with current care home management systems. This section also offers a series of design principles that can be used in the design or renovation of care homes across the UK.

# INTERIOR LAYOUT



Multi-use day room with generic decoration

## INTERIOR

The layout of social areas within the home should mimic a domestic environment so that residents make the link with memories of their own homes. There should be no visual or physical barriers so people can move freely throughout the space without the need for constant supervision. Floor plans should include staff facilities at the centre of the activity areas so that interaction naturally occurs as staff go about their daily routine.

### Room Adjacencies and Relationships

Some homes only provide one room to cater for all group activities and have to include seating areas, televisions as well as furniture for eating. Open plan spaces like these create a burden on residents to interact with each other continuously. Studies of areas like this have shown that they lead to increased withdrawal, conflict among residents and staff burnout.<sup>3</sup>

In open plan, multi-use areas it is very difficult to offer effective information about what activity is taking place at any given time. Residents can become confused as a result and noise levels and visual stimuli cannot be controlled. People also have less choice about which activities they want to be involved in. For these reasons it is essential that rooms have single functions so that residents can choose the activities they want to be a part of and so that sensory information can be tailored to improve recognition of what is going on.

Having separate dining areas also allows layouts and decor to be customised to reflect the specific function of the room. In homes where decoration is generic, environments will not communicate their purpose or help residents understand what they should be doing within that space. Every room should communicate to residents using non-verbal messages that take advantage of all their remaining senses at the same time.<sup>4</sup>

In the sample layout overleaf, room function has been modelled on the relationships that exist in a typical domestic home in the UK. The dining area is located beside the kitchen, the patio is located outside the kitchen door and the garden extends out from the patio. Preserving these relationships and creating rooms full of the objects that are typical of such spaces will visually remind residents what each area is used for offering the best chance for them to orientate themselves within the environment. Good orientation allows people to find places on their own and reduces their dependency on staff having to remind them of their destination.

3. John Zeisel, Joan Hyde, Sue Levkoff, Best practices: An Environmental / Behavior (E/B) model for Alzheimer special care units, *Journal of Alzheimer's Disease*, March - April, Volume 9, Number 2, 1994, p6

4. John Zeisel, *Environmental Neuroscience and Alzheimer's Disease, Alzheimer's Care Quarterly*, October - December, 2005, p6

### Physical and Visual Barriers

To ensure that residents are safe and free to move throughout the space without assistance there must be no visual barriers on floor surfaces. If a person has poor vision and depth of perception, changes in floor colour can be misinterpreted as a hole or a step, creating an unnecessary obstacle. Surfaces need to be the same colour and have no patterns. Floors should also be completely flat and level with no steps, even between the interior and exterior of the building. Skirting boards and handrails could contrast with the colour of the floor or the wall they are fixed to as this helps them to be located. Care must be taken with colour selection as using bright colours or stereotypical colours such as beige can easily make a building look like an institution rather than a home.

Doors to safe exterior spaces should never be locked and should have glass panes to invite residents to see what is on the other side. They need to be wide enough to accommodate wheelchairs. In this sample layout the door is a distinctive red because it represents the back door to a kitchen which is often painted in such colours. This also serves to highlight the door and encourage residents to go outside.

The room layout and furniture should also help people with poor mobility to safely navigate the space. Residents who have difficulty moving will use any piece of furniture or fitting to balance themselves as they go through a room. Furniture should be stable enough to give them support and layouts should have direct lines of access. Arranging chairs, worktops, dressers and anything else in the space with a surface to lean on can greatly improve safety and mobility without making the environment look institutional.

### Staff Work Areas

The layout places the activity coordinator's office next to the kitchen area with a good

view of the room and adjoining garden. This enables materials and props for group activities to be kept close at hand.

In the kitchen area there is a counter space for activities staff to do paperwork. This has been deliberately included so that staff can remain vigilant and cater for any needs as they arise. It also allows for more informal and impromptu activities to take place between residents and staff. The environment holds the potential for casual, unplanned interaction such as taking a walk in the garden or enjoying a cup of tea together.

## INTERIOR LAYOUT

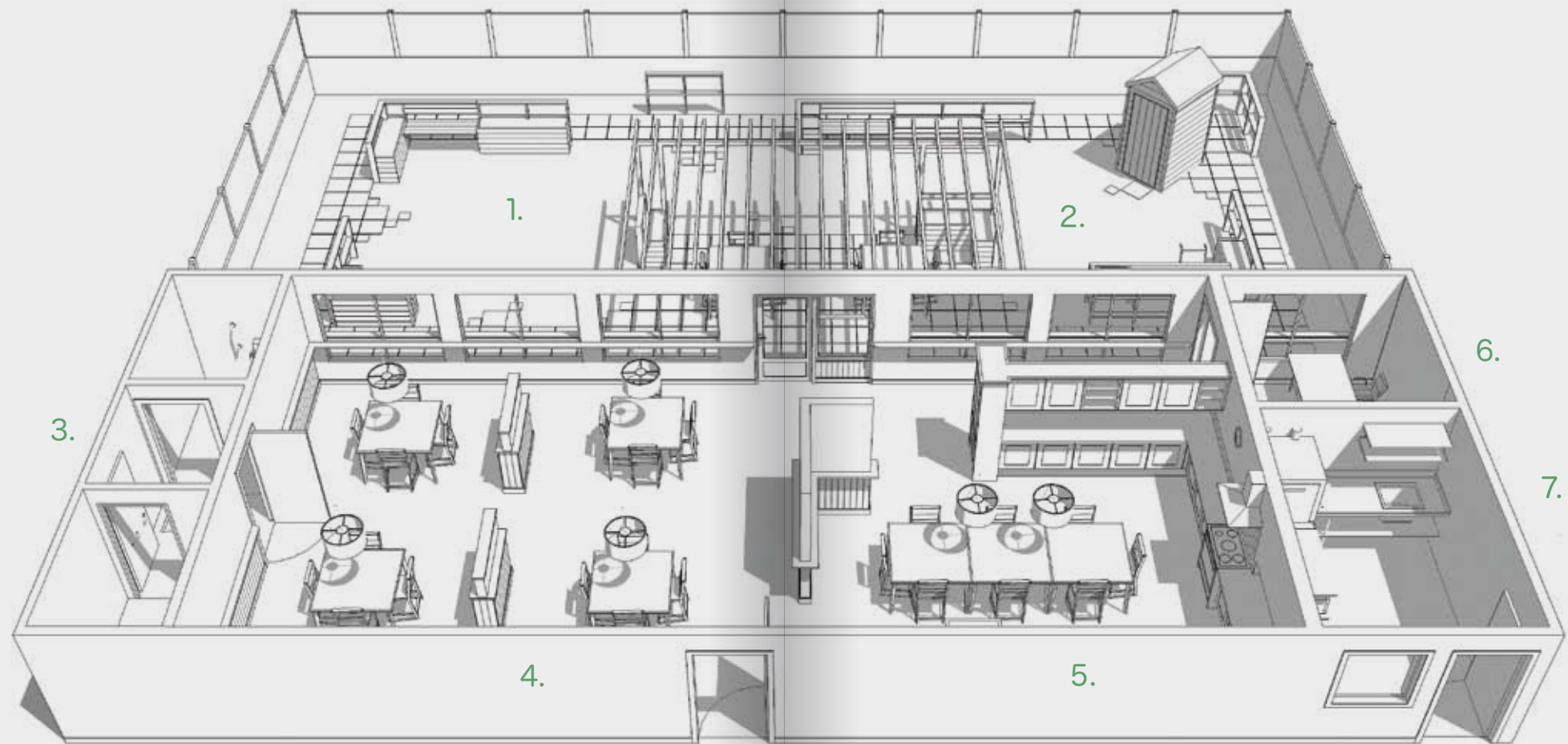

INTERIOR LAYOUT

- 1. Patio
- 2. Garden and Planting Area
- 3. Toilets
- 4. Dining room
- 5. Eat in Kitchen
- 6. Activities Office
- 7. Service Area

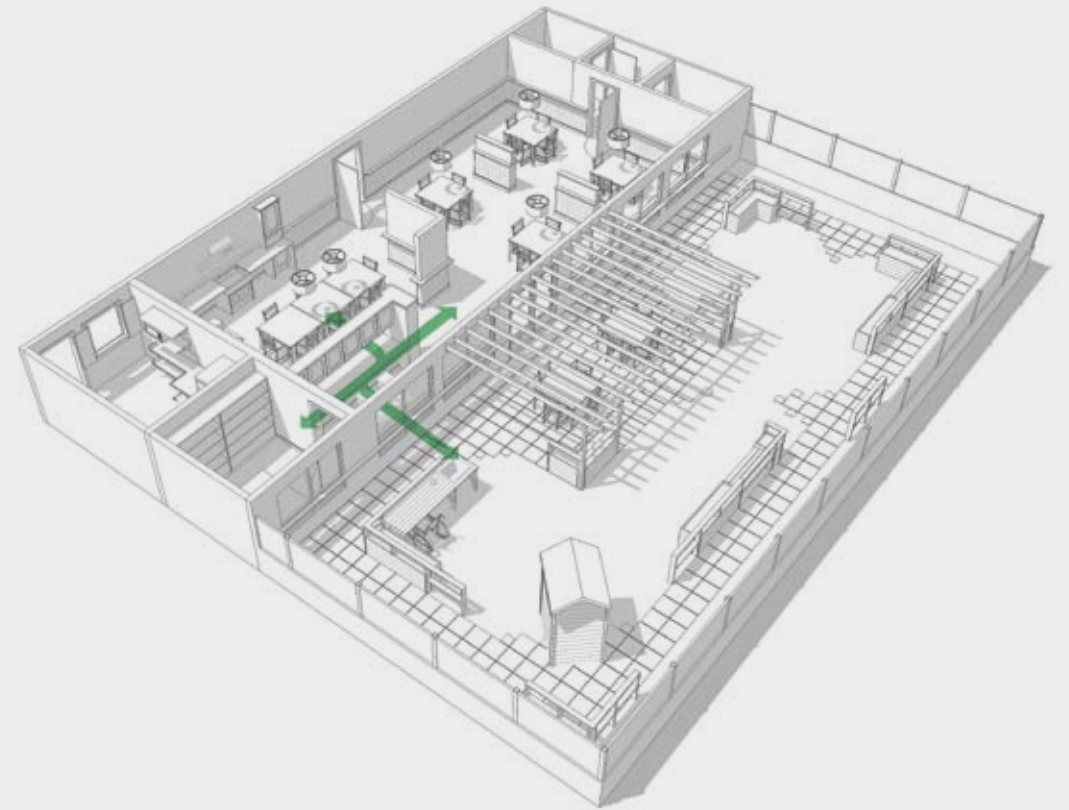

#### STAFF WORK AREAS

-

Working area with adjacent office for carers to do paperwork while maintaining good views of surrounding spaces (shown in green).

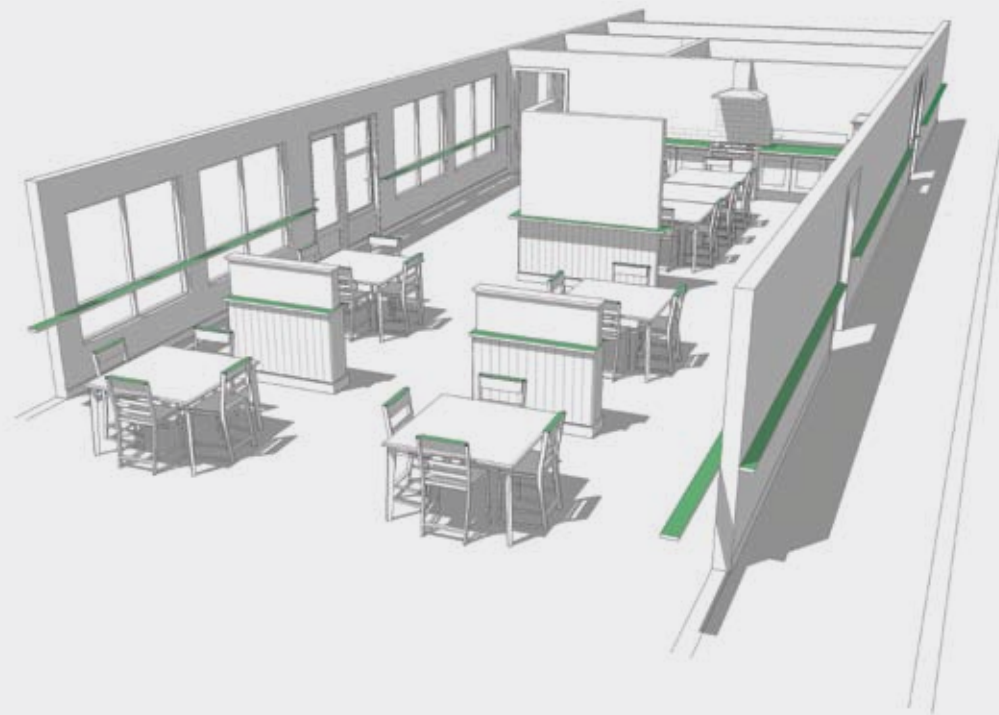

#### LEANING SURFACES

—  
Furniture and walls including leaning surfaces for people with poor mobility (shown in green).

---

## KITCHEN AREA

---

### EAT-IN KITCHEN

---

Eat-in kitchens should be included in the design of dining environments. They create excellent opportunities for interaction between staff and residents and provide a permanent and useful amenity to run activities such as baking groups using space within the home that is often redundant between meal times. They also offer a practical way to improve sensory orientation for residents.

### Heart of the Home

---

Even as a person with dementia loses their ability to communicate through language, they maintain their senses of smell, taste and touch.<sup>5</sup> As Tessa Perrin points out in *Food Glorious Food*, the television has come to be the heart of most contemporary homes, but this was not always been the case. For previous generations the kitchen was the hub of the family and the cornerstone of daily life. It was the warmest place in the home and where the mother in the family was usually located.<sup>6</sup> Kitchens tap into the most fundamental and instinctive memories. Eating areas that look and feel like a kitchen, and that allow the smell and sound of cooking to permeate, can be a powerful way of evoking positive memories and indicating that a meal is about to take place.

Kitchens provide an opportunity to provide sensory messages that can communicate to residents of varying ability in a way that transcends language. Baking bread and filling the rooms with the aroma at lunchtime ignites the senses and communicates what is happening in a way that words never can. It is a good way to provide a homely atmosphere in which people can delight in the sensual experience of food.

---

5. John Zeisel, Environmental Neuroscience and Alzheimer's Disease, *Alzheimer's Care Quarterly*, October–December, 2005, p6

6. Tessa Perrin, *The Kitchen the Heart of Every Home*, Food Glorious Food, Hawker Publications, 2003 p87

---

### Food Activities

The kitchen can also be an ideal place to involve residents in the preparation and cooking of food. Two-thirds of care home residents are women from a generation that was generally responsible for running the home and getting meals ready for the family. Activities that centre on tasks such as cooking tap into strong procedural memories of how to do things and offer a level of fulfillment for residents. In visits it was evident that residents taking part in such groups were treated with more respect by carers and seemed more engaged and contented in what they were doing, even if their roles were passive.

### Split Kitchen

As the picture on the following page shows, the key to providing an activities kitchen within the layout of existing care homes is to split it into two sections. The first contains services that are necessary for the running of a large-scale catering system. The second section houses a therapeutic kitchen in which everything is geared towards orientation, engagement and safety.

In the services area, which is deliberately kept separate from the residential living area, there is a serving space, warming drawers, preparation area, microwave, fridge and food storage. All the commercial features needed to achieve efficient food distribution are present. The service hatch opens into the corridor to avoid staff having to distribute food from the dining area where residents are concentrating on their meals. This reduces visual distraction and noise levels during the meal.

In the activities kitchen everything looks more like a domestic home. There is a large cooker, worktops, a clock and appliances such as kettles and weighing scales. All these items aim to trigger memories of kitchen activities that residents would have been involved within their own homes. At the centre,

there is a large family-style table for groups of residents to congregate. This space caters for events such as baking, planning parties, making pudding, icing cakes, baking biscuits and anything else that is food-related.

Unobtrusive safety features include lockable switches for potentially dangerous electrical equipment which can be kept in a cupboard within the kitchen or in the adjoining office. Under-counter storage can be both camouflaged and lockable to keep dangerous items out of casual reach yet keep them accessible for supervised activity. By extending countertops further from the edges of cupboards and using locks at the top, the cupboard door handles and locks are naturally hidden from residents.

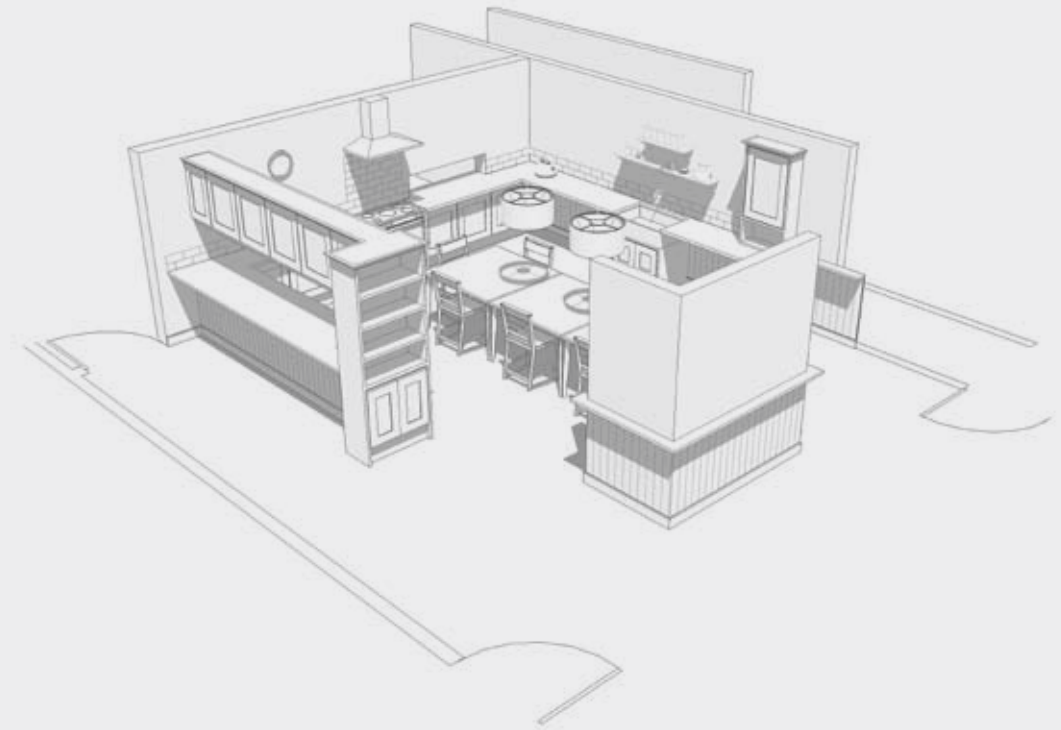

KITCHEN AREA

Eat in Kitchen including archetypal appliances, decor and unobtrusive safety feature.

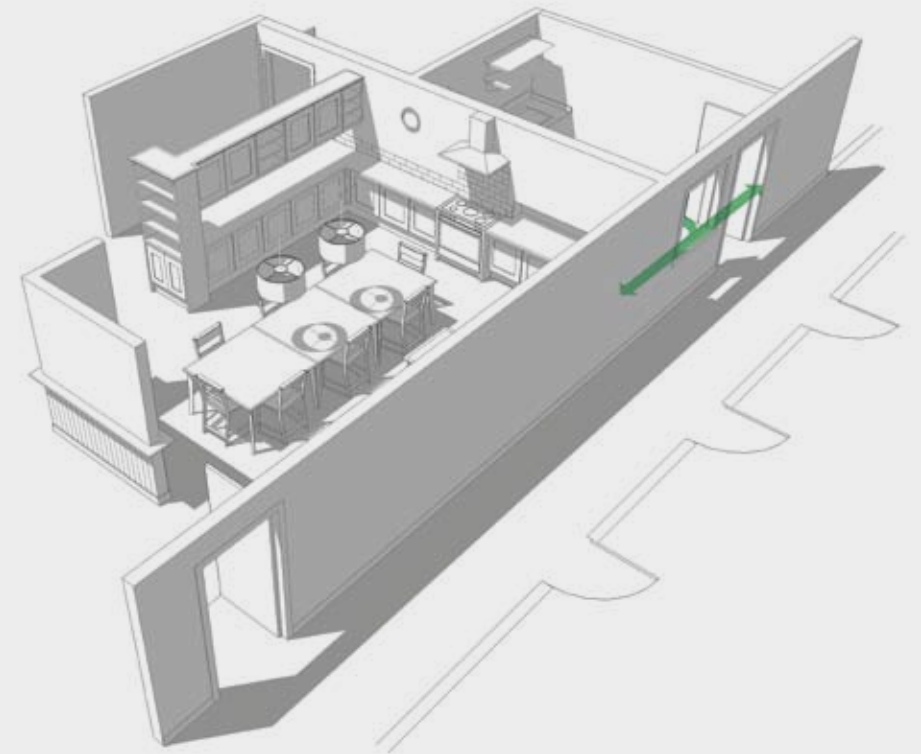

#### SPLIT KITCHEN

—  
Split kitchen including activities and service area. Food distributed through corridor to minimize disturbance for residents who are dining (shown in green).

---

## DINING AREA

---

### DINING

---

The big challenge when designing dining areas is to create a comfortable and appealing atmosphere and avoid elements that either detract from a resident's remaining ability or make the environment feel institutional. Three key ideas that dining areas should address are the ability to control stimuli, the need for accessible tables and the use of good quality lighting.

#### Controlling Stimuli

---

As dementia progresses, a person can begin to have difficulty concentrating on a meal and become sensitive to excessive sensory stimulation. Dining areas that contain too many people, have high levels of noise or simply have too many visual distractions such as people passing by, can be stressful and distracting. If a person is over-stimulated they may try to leave but be unable to articulate the reasons why they wish to do so. In an effort to avoid such situations, people may demand to stay in their rooms, alienating themselves from social contact with others.

To remove excess stimuli from the eating environment it is key that service areas are located outside the dining area. Spaces can be broken up using moveable dividers. The dividers shown in the image are at a height that allows people to see over them when standing. Staff can therefore see easily into the space but there is more privacy and less distraction for the residents when seated. The partitions are mobile so that spaces can be divided according to different needs on any given day. It is important to remember that some people will need more privacy to focus on a meal while others will be more socially active. Positive stimuli can also be important. In this layout the dining area is a part of the kitchen so that smells and sounds associated with mealtimes can start to stimulate appetite.

Noise levels can be controlled by using sound absorbent materials in the space. Items such as curtains and other soft materials can reduce noise. In some European care homes, cork is used as flooring as it looks very domestic, is cleanable but is also sound absorbent and absorbs impact if a person falls. For residents who may need a toilet due to incontinence, locating a toilet near to the dining room is advisable. This offers reassurance and allows people who have limited mobility to feel more comfortable about eating with others in a social space.

### Inclusive Table

Care homes cater for people of varying levels of mobility. Very often there is a substantial number of wheelchair users in a home but the dining tables cannot accommodate a wheel chair. They have central columns or support structures which prevent wheelchair arms from clearing the underside of the table. This means that wheelchair users cannot sit close enough to the food, making the task of eating more difficult and often resulting in embarrassing spillages.

The table designed as part of this project is flat bottomed and at a height of 74cm allowing most types of wheelchairs to fit underneath. It is square so that it can be joined with other tables or used on its own. This gives a degree of flexibility which allows residents to eat in smaller groups or be brought together in larger groups on special occasions such as Christmas.

The edges are rounded to be more tactile and limit impact damage should anyone be unfortunate enough to fall and connect with the table on their way down. The table surface is also contrasted to its edges to help people with low vision.

### Inclusive Light

Good quality lighting is essential in dining areas to ensure that older residents with degrees of visual impairment can comfortably

enjoy their meal. Important issues to be considered include lighting levels, glare, depth of perception and flexibility. The example shown on the following page has adopted these into a single retrofit light that can be fitted in existing environments.

Studies have shown that older individuals can require three times as much light as younger individuals.<sup>7</sup> This fitting uses a powerful bulb and dimmer so that each table can be tuned to the needs of the people sitting at it. The light can be adjusted from 400 to 1200 Lux catering for a range of demands.

For older people who might have decreased pupil reaction time and less elasticity of the lens, adapting quickly to changes in lighting level can become more difficult and create a sensitivity to glare.<sup>8</sup> The light includes an acrylic diffuser to alleviate this problem so that the eye is never exposed to a naked bulb.

It is important to be able to retract the light to the ceiling or move it if the layout of the room changes. The fitting therefore has a central cable that uses a hook and pulley system allowing it to be temporarily moved for dining events or permanently moved by repositioning the hook.

7. Jennifer A Brush, Margaret P. Calkins, Design for Dining, Building Ideas, Alzheimer's Care Quarterly, January–March, 2003, p75

8. Baucom AH. Hospitality Design for the Graying Generation, John Wiley & Sons, 1996, p21

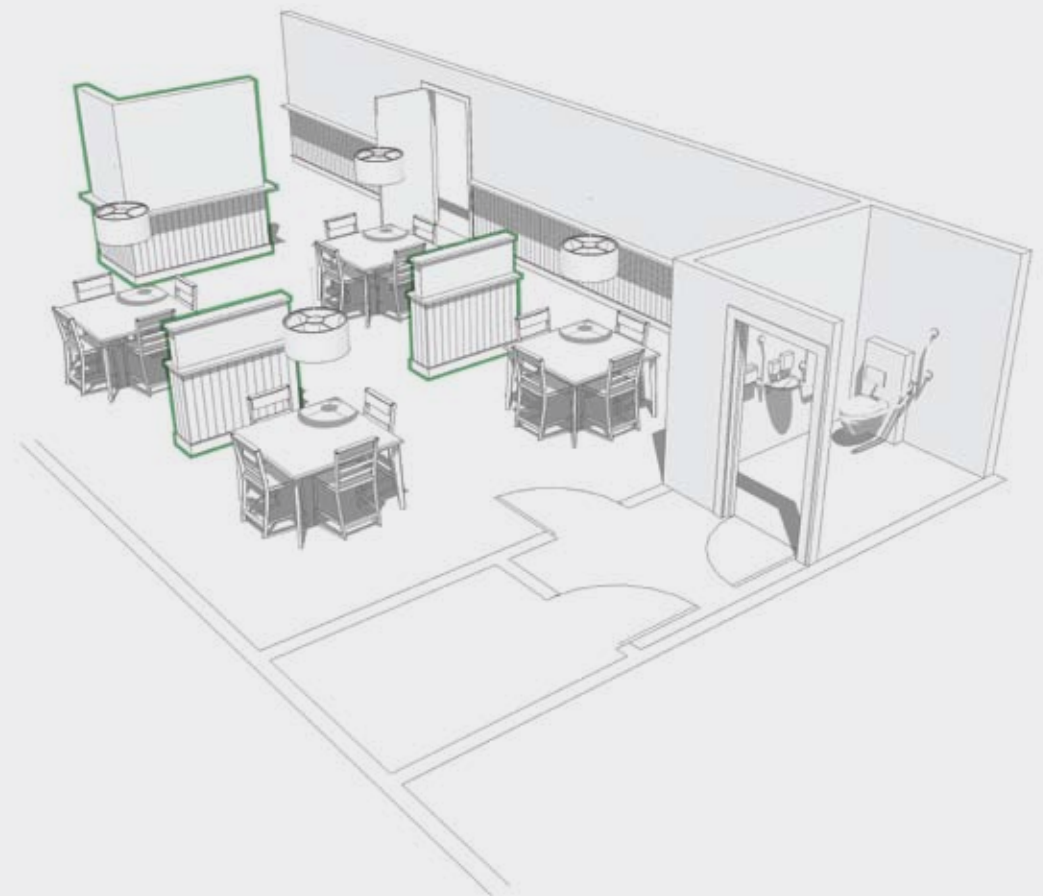

DINING AREA

Dinning area including kitchen, toilets and movable screens (shown in green).



Flat-bottomed table for wheelchair access and adjustable light to improve visual acuity.

---

## GARDEN AREA

---

### INCLUSIVE GARDEN

---

Gardens are often not used to their full potential but are a good space for residents and carers to enjoy. Daily activities such as walking can be useful forms of exercise and spending time outside can also promote a healthy appetite. Gardens can also improve nutritional health and promote a better state of mind by providing views of nature in the winter and a space to relax amongst greenery in the summer.

Where residents are not free to leave the home unaccompanied for reasons of safety, some free access to the outside is a necessity. This allows a connection to the outside world, recognition of the seasons and the chance to engage in activities based around growing food during the spring and summer months.

Gardens should be safe and navigable so that residents can enjoy unrestricted access to them. It is important to include seating and patios to provide opportunities for residents to eat outside. Potting areas can allow residents to help with gardening and the staff and activity coordinators can use outdoor spaces for group gatherings and events.

### Safe and Navigable

---

Ensuring that residents can access the garden without risk to themselves is essential for their independence and wellbeing. Gardens that are unsafe will require staff supervision, restricting access, adding an unnecessary duty for staff and reducing resident choice.

Gardens should be visually accessible from the inside of the home. Out of sight means out of mind. Obvious doorways to the garden will encourage residents to use them. In the garden design shown here, access is provided through a backdoor from the kitchen because of its direct similarity to a normal domestic home. There are no steps and the flat surface of the interior blends into the exterior without

---

any significant change of colour so as not to create a visual barrier.

The circumference of the garden includes flat paving stones offering easy access for wheelchair users and avoiding trip hazards for those with poor mobility. Seating has been integrated to allow residents to rest as they walk. Lean rails have been integrated into all elements of the garden to offer support for unsteady legs.

Garden walls are also 2.2 metres high and there are no surfaces, trees or structures beside the wall. Furniture is heavy and difficult to move without assistance. These precautions prevent residents climbing over the wall.

### Opportunities for Activity

A well-designed garden is a useful amenity when planning and running outdoor events and activities. Basic features like a lawn, potting areas, seating and objects such as sheds can help orientate residents as they are typical objects found within the domestic home.

By including a gardening area, ground staff can contribute to activities for residents without using up extra care staff time. Gardening areas should include raised workbenches that are wheelchair accessible for potting plants or running flower arranging groups outdoors. Raised beds will allow residents to help with planting shrubs or with the weeding without needing to kneel on the ground.

An accessible tap means that residents who are able can help with the watering every day. A shed can offer a domain tailored towards male residents many of whom would have had their own sheds in their back garden. Greenhouses create an entire world of opportunity for growing flowers and vegetables, extending the growing season.

Basic features like a lawn allow for activities such as croquet or a chance for a picnic on a hot day. Outside seating and a patio add variety to meal times and an opportunity to eat in the sunlight and fresh air. Adding a barbeque can be a good way of gathering

residents together, filling the garden with the smells of cooking and involving the care home community in a social, summer activity.

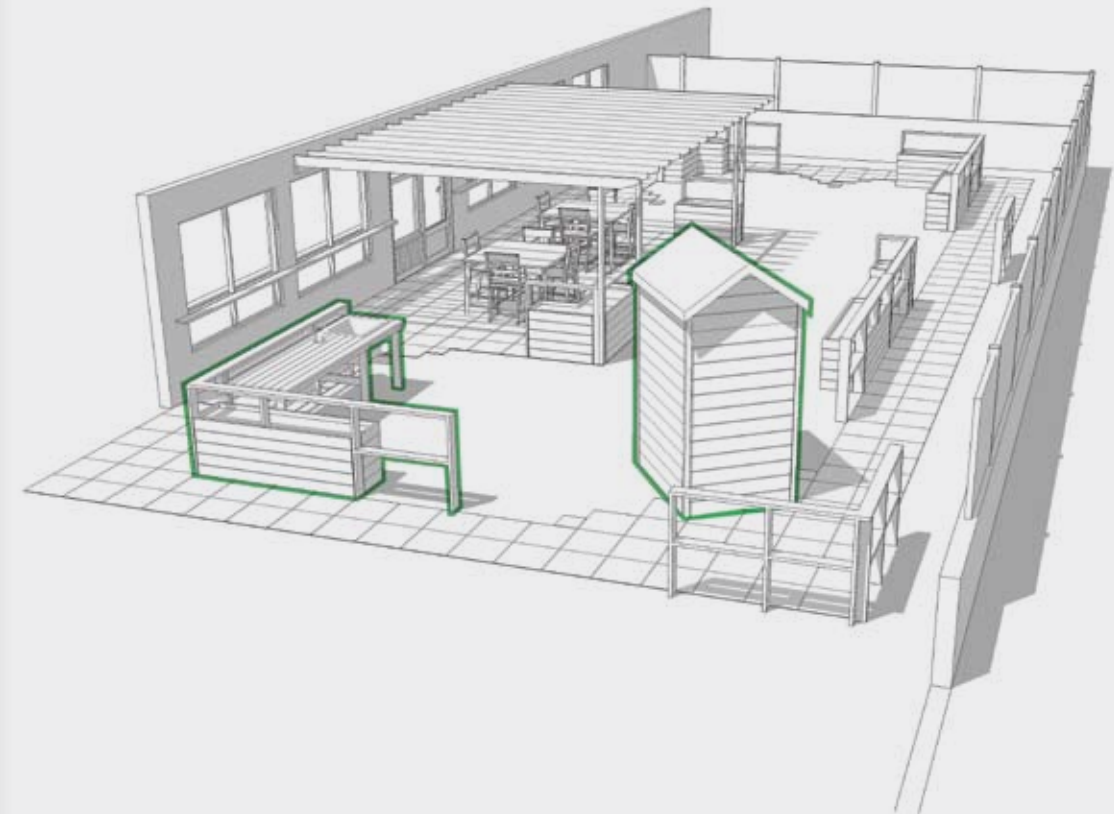

### GARDEN

Garden including lean rails, raised beds, patio and potting area (shown in green).

# TABLEWARE



Tablesetting in existing care home

## TABLEWARE

The eating skills of residents in the mid to late stages of dementia can be improved and maintained through the use of appropriately designed tableware. This section highlights key features needed to improve the experience of meal times. An entire range of tableware is proposed here, designed to meet the varying abilities of people who find it challenging to eat due to dementia or reduced physical ability. Key areas of focus include reduction in visual acuity and dexterity.

To examine which features appealed to residents and best supported their needs, an audit of existing products was used as a tool to discuss current solutions on the market. Care staff and residents all agreed assistive tableware was often childish in appearance and not age appropriate. Materials such as plastics were less desirable because of their cheap tactile quality and intrinsic colour schemes and that were either bright and childish, or beige, associated with assistive technology therefore becoming stigmatising.

Products also appeared to be ill-considered for the care home setting and included basic failings that made them less functional and appealing. Problems included an inability to stack, materials that aged badly and the use of colours, particularly in plates, that made the food look unappealing.

From research conducted in a variety of care homes it became clear that assistive tableware was often not stocked despite the fact that residents could have benefitted from them. Some managers opted not to include them in their kitchens because of the lack of aesthetic appeal. It was felt that they detracted from the quality of the meal.

Current assistive tableware stood out from other pieces at the table and added a sense of stigma to the people using them. Care facilities have residents of diverse abilities and those residents who had to use assistive table settings felt different from the residents who could use standard tableware.

The design of this new range of tableware sets out to achieve a number of goals.

It aims to:

- 1 Highlight specific features that could benefit older people in care.
- 2 Provide commercially viable solutions that were durable and that could be permanently stocked in care homes.
- 3 Create a range that matched as a set and formed a complete table setting so that people were not singled out by the objects they had to use.
- 4 Ensure that solutions maintained a resemblance to domestic tableware so that plates looked like plates and cups which looked like cups. This was essential to ensure that the function of the objects remained clear and obvious for people at the more advanced stages of dementia.

---

## VISUAL IMPAIRMENT

---

### TABLEWARE FOR VISUALLY IMPAIRED PEOPLE

---

For people with low vision it is important to use plates that create good contrast between both the plate and table and also the food and the plate. For most food, white plates can be used, but for potatoes, rice or pasta that is light in colour, having the option of a coloured plate can be beneficial. Dark Navy is a good colour for tableware as it uses a tone that does not detract from the appeal of the food. It also contrasts with most food groups. Plates in this style have been widely available since the 1940s and would therefore be recognisable to residents in care.

Some research in the field suggests that brightly coloured plates can help attract attention and keep residents in the latter stages of dementia focused on a meal. However this is an institutional approach and undermines one basic requirement of a meal to be aesthetically appealing. An alternative solution is to cook food that is more colourful, attractive and appetising.

The same logic concerning color contrast can be applied to cups. In this example, colour has been applied so that people with low visual acuity can easily locate handle and rim. Additional features include angled sides to reduce the amount the cup has to be tipped. The handle is large enough to be easily gripped and the opening at the top is wide in order to allow a person's nose to fit inside the cup when it is tipped, thus avoiding excessive head movement.



Colour contrast for visual impairment



Plate with high-lipped profile helps push food onto the spoon

## REDUCED COMPLEXITY

### TABLEWARE TO REDUCE COMPLEXITY

As dementia progresses, some people can begin to lose their eating skills or find it increasingly difficult to concentrate on the task of eating. They can become confused by too many pieces of tableware or multiple items of cutlery at their place setting. A common strategy is to simplify the amount of utensils by providing just a plate and spoon with pureed or diced food that can be eaten without the need to be cut up by the resident. This has proved to be very successful as it simplifies the process of eating but still allows a person to feed themselves.

However, one of the difficulties that emerges from this strategy is that residents, who are now only using one piece of cutlery, push the food off the side of the plate when they are trying to pick it up. To address this, the plate contains a high lip in its profile that helps to push the food onto the spoon as a person tries to scoop it up. It turns the motion that usually results in food being spilt onto the table into a way of improving eating skills.

The range includes a bowl that is designed to allow people to pick it up and drink from it. The rims have been extended to create a vessel that can easily be held with two hands. It aims to further reduce the complexity of eating and support people with limited dexterity.

One of the most disliked pieces of tableware commonly used in care homes is a care cup because it is extremely similar in appearance to a baby cup. This item is given to residents with reduced dexterity who can then grip both sides of the cup without burning their hands as they might with a ceramic mug. The three most problematic features that reinforce its association with a baby product include its nipples lid, its two handles and its construction from plastic.

To challenge this design a cup formed from a single piece of ceramic is proposed. The mould has a double skin with an air-filled cavity between the inside and outside surfaces allowing a person to grip the cup without risk of burning themselves. The inner layer is sloped to reduce the amount of movement that a person's neck has to make when drinking. The lid minimises the association to the nipple of a baby cup by elongating the form around the rim.



Bowl with extended rims for easy grip



Double-skinned ceramic cup for easy grip

## ASSISTANCE

### TABLEWARE FOR ASSISTANCE

Feeding a resident with dementia presents one of the most challenging tasks in a carer's day.<sup>9</sup> Ensuring the experience is a positive one for the person being fed requires a great deal of empathy and skill as the act of feeding another person can be a delicate experience. Where possible, it is helpful for the carer to have a strong connection to the person being fed, adopt the least aggressive position by sitting below their sight line and giving mouthfuls at a pace that they are comfortable with.

Each of the assistive pieces in this range has been designed to be easily held by care workers and encourages them to hold the plate in the sensory range of the person they are feeding so that they can see and smell what they are eating. The plate shape allows the carer to orientate it in an 'offering position' and draw it under the person's chin to minimise the risk of spilling.

The pieces have been reduced in weight and allow staff to get a good grip so that they do not drop them if the resident grabs hold of the side as can sometimes occur when they want to be more involved in the process. A version of the plate with a central divide is also available for people who require a soft food diet. This ensures that different food groups such as mashed potatoes, mince or mushy peas stay separated and that people can still enjoy the uniqueness of each flavour.

The range includes a plate, bowl and lid for cups which can be used to reduce the risk of spilling liquid on those being assisted.



Cup with lid to avoid spillage

–  
9. Philips LR, Van Ort  
S Measurement of  
Mealtime Interactions  
among Persons  
with Dementing  
Disorders, Journal of  
Nursing Measurement,  
1993, p41-55



Assistive plate with divide to ensure the separation of soft foods



Easy grip on underside of assistive plate



---

## SECTION 3. BEDROOM

---

---



A typical bed in a UK carehome

## THE BEDROOM AND CARE:

Within the care setting, the bedroom is the one place that can be identified as a person's own. It is a place of refuge where identity is reinforced through familiar objects and environmental cues. It is an oasis within the care community, the importance of which can have incalculable value to residents, family and friends. The bedroom provides carers with a constant reminder that where they work is where another person lives. It is also a place where people right across the spectrum of ability must be supported in carrying out a wide range of daily living tasks.

### THE EXISTING BEDROOM ENVIRONMENT IN CARE

The majority of bedrooms in care are for single use, with a small proportion of rooms designed for sharing. According to a majority of the homes visited, each single bedroom is allocated approximately 12m<sup>2</sup>, with twin-shares being allocated approximately 20m<sup>2</sup>; this makes space limited but more than adequate. In addition to these specifications many bedrooms are afforded en-suite bathrooms which give a resident a private area to bathe, groom and visit the toilet, albeit with the assistance of carers in the advanced stages of dementia. Those without en-suites will find communal toilets and bathing facilities nearby.

Generally speaking, the bedrooms themselves have a similar aesthetic to the rest of the care home in terms of carpeting and wall finishes, and can be located via a number of corridors that come off main communal areas such as dining and activity rooms. These corridors usually have a distinguishing feature such as a wall colour, street name or an enclave with a memorable object to assist with way finding. The entrance to a person's bedroom is often marked with a memory box, which helps the resident to identify their own room.

### Where Residents are Spending Time

As explained earlier, people today are being cared for at home for longer before going into residential care. This means that a higher proportion of residents living in care are at a more advanced stage of dementia. As a result many residents spend a significant amount of time in their own room rather than in the communal areas of the care home. Some do so because they find interacting with other residents in the home daunting, others remain in their bedroom because of mobility problems. There is a debate among care professionals as to whether it is good care practice to promote the benefits of spending more time in a resident's own environment rather than encourage residents to spend time in sitting rooms when activities aren't taking place.

The benefits of spending more time in one's own bedroom is based on that environment being tailored to a person's needs. It also means a greater level of separation from other residents. The other

side of the coin is that residents may feel more isolated as well as requiring larger numbers of staff to actively engage with other people.

Whether or not it is good care practice, more time is being spent in the bedroom, and this daily reality affects its significance as a space. The bedroom becomes a private living space that fulfils many of the tasks of a studio apartment rather than merely those of a bedroom. Bedroom-based tasks like sleeping, dressing and grooming are, of course, still relevant. However eating, entertaining, reading, watching TV and taking part in shared activities also take place in this space.

### What People with Dementia Say They Want

It was not possible to extensively interview care residents with dementia about their bedrooms because of cognition, speech and comprehension difficulties. So in order to gather further research insights, workshops were organised for people living with early to mid stages of dementia. What emerged from our study was that people were very nervous and afraid of the prospect of going into care. The ability to do something yourself, to retain independence and remain functioning was a key concern for all the workshop participants – and they suggested that they were unable to achieve this in care.

Care residents told us that they didn't like the 'hospital feel' of some bedrooms and the lack of quality of some of the supplied furniture. When asked about specific items such as a wardrobe, both men and women in the group were adamant that functionality and ease of use were of paramount importance. Generally speaking, the men in the group did not mind what it looked like as long as it did the job; women, however, talked about the importance of colours and taking pride in their surroundings.

### A Person-Centred Design Approach

There has rightly been much emphasis on person-centred care strategies, as first identified by Tom Kitwood<sup>10</sup>, in order to develop good models of care for staff and enable residents to achieve their full potential. However less attention has been given to people-centred design – to those supporting environmental and product designs that enhance care.

The result is a gap between best practice care policies and best practice product policies. For example, soap dispensers developed for hospitals are sometimes used in a resident's private en suite bathroom. This is inappropriate as such a dispenser may well confuse a person with dementia with its graphics, branding and unfamiliar mode of operation. As a result a resident may stop being able to wash their hands independently sooner than necessary.

Care providers make purchasing decisions from manufacturer-supplied architectural drawings and many elements that are specified do not address dementia. This is partly because some UK care

manufacturers only provide basic architectural specifications in their catalogues – if they supplied more information about dementia-related features then product purchasing could be based more accurately on residents' needs. The designers and architects who make the purchasing decisions for care homes could assess where a product is effective, where it needs to be improved and ultimately which product would benefit the residents in their care facility.

Product purchasing decisions should support each resident's range of capabilities. An *ad hoc* approach to the development of products and environments has created a make-do approach by carers and residents in their daily routines, disabling residents from living to their full potential.

Observation of where residents, carers and family have made interventions in bedrooms has suggested where improvements to existing products and environments can begin. One family stuck up photos on the front of the wardrobe along with printouts saying 'My name is Jack'. They felt that this helped their father, as this was a place where the sign would be seen many times a day. Another resident had his drawers labelled with both writing and hand-drawn images so that he was able to find things without the usual confusion. One resident was even observed creating a makeshift key out of a spoon for an unused lock on his bedroom door.

Interventions are often devised for individuals by forward thinking family members and friends, so not all care residents can reap the functional benefits. There are also negative connotations that can emerge from this makeshift approach – hand-drawn socks and spoon keys can lead to unintentional stigma for people with dementia. However such moments of improvisation and inspiration offer unique insights into the daily lives of residents with dementia, and when combined with further, structured research into person-centred care, can help create the new products that are required.

### GOALS AND AIMS

The following sections of this publication describe the research and design of exemplar products for the bedroom of a person living with dementia in care. There are two areas of focus: personalisation of the environment and the activity of dressing. The first looks at how residents can get the most out of their own space and at how this space can be customised so that they are surrounded by memories and reminders of their life and personality, communicating to them that they belong. The second area of focus looks at how dressing is a personal and private experience that will require more assistance the longer a person is resident in a care home. A key question is: how can people face this transition with dignity?

<sup>10</sup> Tom Kitwood, *Dementia Reconsidered: The Person Comes First*, Open University Press, 1997

# PERSONALISATION



Personalisation in an existing bedroom

## PERSONALISATION

Personalisation is an expression of self. The ability to personalise one's immediate environment can have invaluable impact on the life of a resident. It can help provide fundamental cues to their identity. Objects and images with personal meaning can provide valuable reminiscence tools for staff, friends and family members to use to communicate with residents – and can also act to separate the resident's personal space from the communal environment outside. An environment that is personalised with loved possessions and photographs – and thus unique to a person in care – can alleviate fears born out of confusion and help a resident feel safer and more at ease.

Change and dementia do not mix well together. Major changes in a care resident's life, routine and environment can cause a lot of stress and some new residents moving from their own home to care are known to exhibit an initial noticeable decline in abilities.

A recent arrival into care was witnessed in a frightened state telling a carer, 'I shouldn't be here, I shouldn't be here'. This person didn't know where they were or why they were there. Simple interventions such as a few pictures on the wall of this individual and her family, a favourite lamp or a wardrobe full of familiar clothes could have provided cues to alleviate her fears.

Personalisation of the environment can reduce anxiety for those moving into care, either autonomously or with the prompting of carers, and demonstrate good care practice in really understanding the resident. Ownership of personal space can help achieve that all important and sometime elusive feeling of pride. A personalised room helps create communication tools for those residents who can no longer verbally communicate in the way they once did about their lives to friends, family, carers and other residents. It can also help provide a visual boundary

between private and communal space, beyond the signifier of an internal door that is often left open.

The contemporary personalisation of private spaces within care varies a great deal. Most care providers are happy to let families redecorate a room to a resident's personal tastes. However lack of money, time or local family means that this opportunity is rarely utilised; in most cases, only a few pictures, personal items or favourite pieces of furniture are brought in. When these personal items are removed from the context of a home and combined with standard care items such as well-used care beds and bedroom furniture, much of the personal value can be lost in the space.

While there is much innovation in new architectural developments for people with dementia, most new care homes are retrofits. New facilities are being built in old hospitals or existing care homes, which have not been designed to cater for the needs of people with dementia. To be cost effective when retrofitting means using as much of what already exists as possible, and changing features and architecture can often be seen as an expensive exercise when the benefits are not truly understood.

## STRUCTURE OF SPACE

---

An environment that has not been specifically developed for residential dementia care can have an adverse effect on the way products and furniture fit into a care room. An analogy is to imagine trying to pass off an office by filling it with bedroom furniture. Although functionally this space could work as a bedroom, it does not have the look and feel of one. It would look and feel like bedroom furniture has been placed in an office. Without a properly bedroom-designed environment, the furniture in the room as well as the person occupying it would feel wrong.

To gain the benefits of a personalised bedroom, the skeletal structure of the room needs to express a different design language from the rest of the care home. When you enter someone's bedroom, it should look, feel, smell and sound like you are stepping into someone's own home, evoking all the senses to remind you that you are leaving the communal care facility and entering an individual's private domain.

Being able to personalise one's environment within care does not just involve putting up a picture or bringing in a favourite armchair. It involves control of the environment in its totality and, in the best-case scenario, would result in redecorating the entire room for every resident that moves in. However in almost all cases, this exercise would be too expensive, time-consuming and disruptive within the care home.

To address these three obstacles to effective personalisation of the care room environment, we can draw on some of the lessons developed in the retail industry. While there are few end use parallels that can be drawn between personalisation in care and merchandising products for sale, there are comparable functionalities in terms of ease of use and modularity.

Borrowed retail display techniques can give friends, family and carers the ability to

completely renovate a space to a resident's unique needs and personal tastes without requiring any specialist training, in a fraction of the time, with little or no budget and without causing any damage in the process. Care providers can benefit from the millions invested by the retail industry in developing customisable, modular display systems in order to improve the quality of their care environments.

By using a visually unobtrusive, wall mounted hook system such as the one shown here, an entire room can be personalised by family or carers as part of an introductory activity with a resident. Neutral colours on the walls can provide a base that residents and their helpers can later customise. This durable hook system means that the whole room benefits from customisation without undue disruption or cost.

## BEDROOM

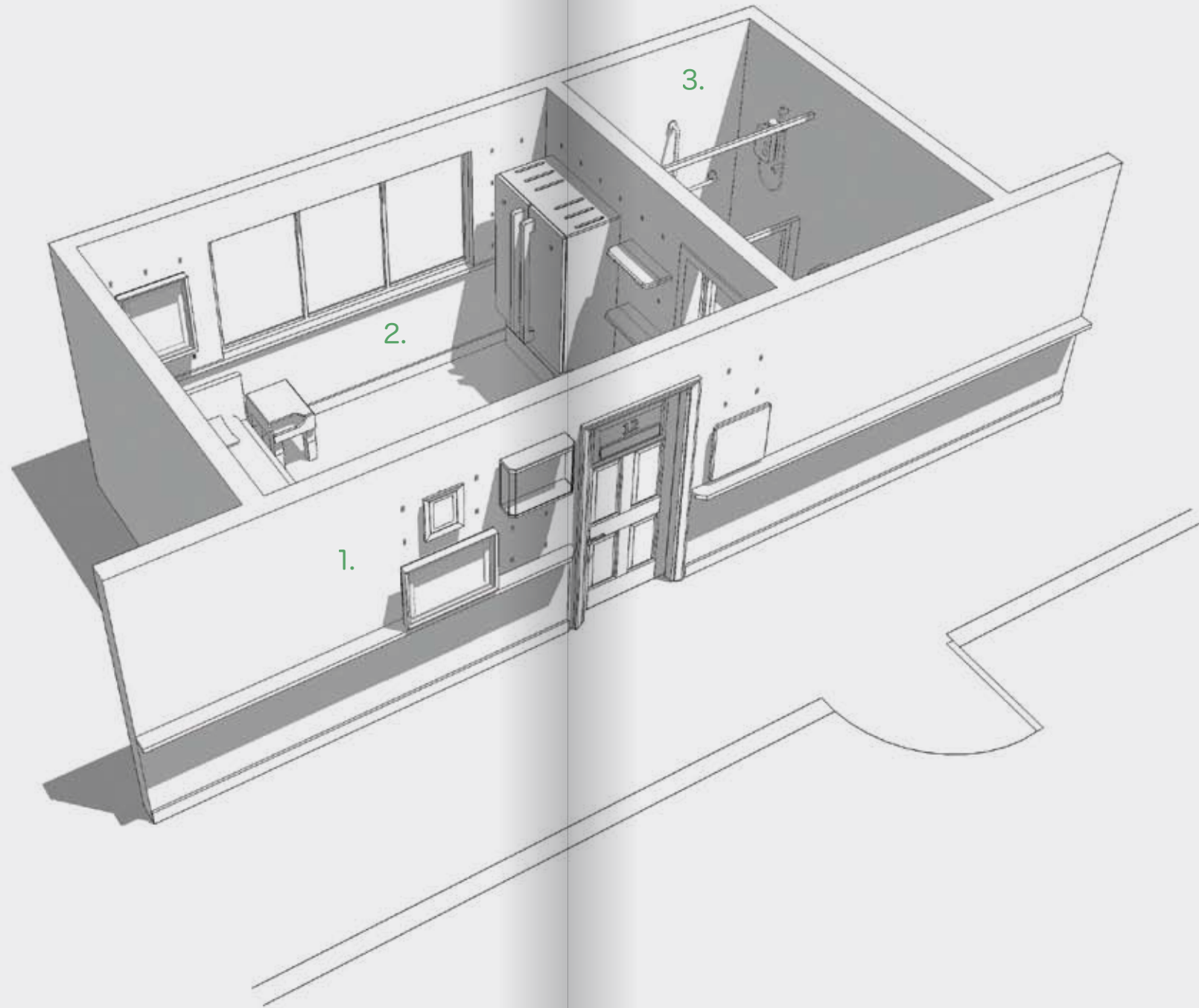

KEY AREAS RELATING TO PRIVATE SPACE

- 1. Hallway Personalisation Layout
- 2. Bedroom
- 3. Toilet / Bathroom

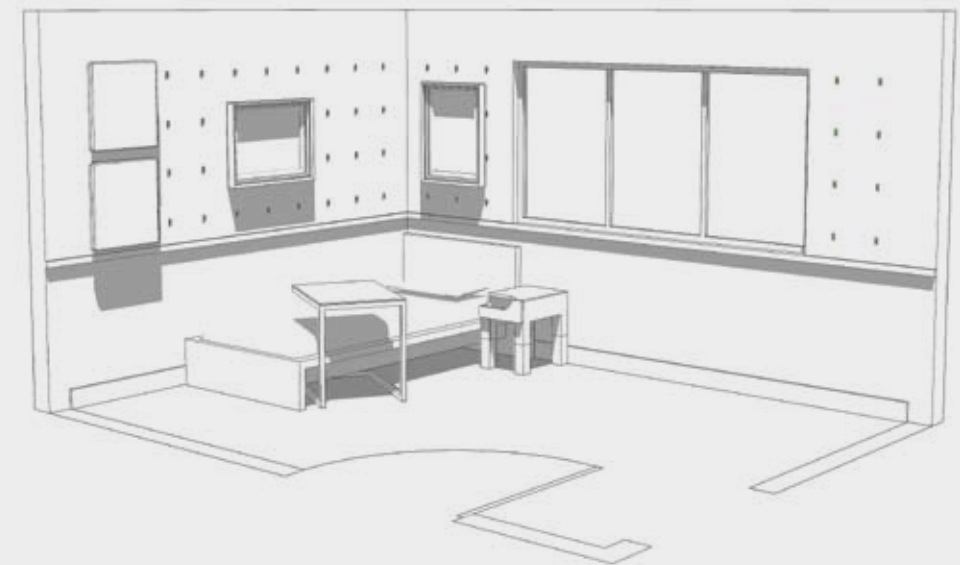
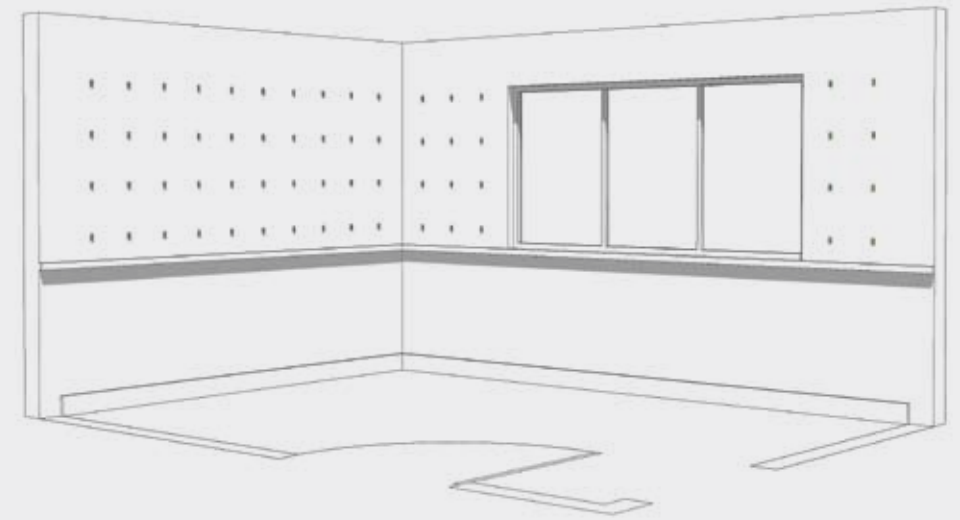

CUSTOMISATION

-  
New personalisation system  
for existing bedrooms (in green).

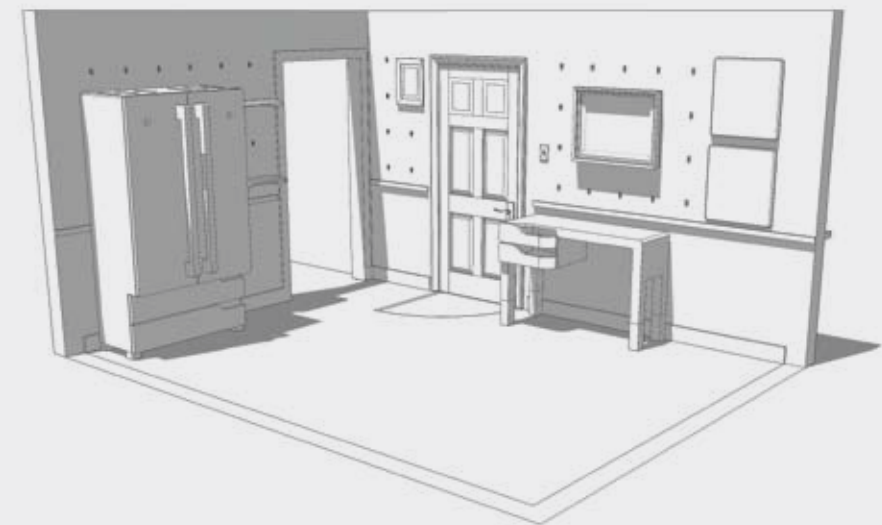

CUSTOMISATION

-  
New personalisation system  
for existing bedrooms (in green).

---

## CUSTOMISATION

---

Pictures, shelves and other material can be moved around the bedroom environment without causing any damage or disruption and in a fraction of the time it normally takes. The ability to be able to quickly 'edit' an interior means that residents can be an integral part of the process, making the personalisation of the room a positive activity for family, residents and carers to participate in upon an individual's arrival in the care home.

The furniture that supports a home like bedroom environment does not share an aesthetic relation to the retail industry so the skeletal structure is where that relationship ends. New products could be developed to fit the system or existing products could be retrofitted to allow customisation with a domestic aesthetic. This approach means that furniture previously fixed in specific locations could be moved anywhere within the environment.

A shelf, for example, could be placed in different positions in the room before a person decides they are happy with the location, without causing any damage to the walls in the process. Extra shelving could be ordered from existing stock to further customise the space and colour panels could be fitted into the same system to change the feel and atmosphere of the room. Picture frames with friendly faces could be placed in positions unique to the individual, making each bedroom different from each other and private space quite distinct from the communal areas of the care home.

## BEDROOM ENTRANCE

The boundary between the communal areas of residential care and the private domain of the individual psychologically represents one of the most important transitions. This boundary marks the end of one space and the beginning of another. Different rules in each space and lack of differentiation between communal and private space can cause conflicts. Residents sometimes enter someone else's room by accident or change their clothes while the door is open; carers leave notes taped to the walls about a resident's condition. The importance of setting this boundary is often overlooked in current care design, a state of affairs compounded by retrofit care facilities being unsympathetic to unique entrances to private rooms.

Access from communal areas to private bedrooms in most current care home design is made via the use of long institutionalised corridors. Differentiation between corridors is common, with different colour treatments to assist in wayfinding. The point at which access is usually made into private rooms, however, tends to be generic with different characteristics such as nametags, memory boxes and door treatments repeated for each bedroom.

This repetition can be confusing and disorienting for residents who have mobility or memory problems, affecting their ability to navigate their environment. The institutional effect of this repetition works against the mantra of creating a 'home-like' environment within residential care.

One way to improve way finding is to create 'landmarks' in certain places throughout the hallway. Personalising this area on a case-by-case basis, like the interior of the bedroom, can provide many markers that assist personal identification by the individual resident, remind everyone in the home who that person is and communicate a little about their personal history.

Such personalisation techniques go part of the way to developing unique street like entrances to private rooms within the care home.

The memory box is widely used throughout care homes and has been around for a long time. It is hailed as an effective personalisation tool that can assist way finding, enhance communication and support identity. It has been largely unchanged in design since it was first developed. However the memory box provides a platform for how the transitional entrance area can create more of a boundary between communal and private areas of the care home.

It is a landmark in its own right, a potential object of pride for the resident, and greater personalisation of the memory box could also provide more communication cues for carers and family. Before dementia set in, perhaps a well-kept front lawn provided the boundary between private and public, addressing the outside world by saying something about the resident. Within the care home, there needs to be a new type of personalised transition space to express individual values to others.

The transition from public to private space in care homes can be informed by the visual elements of commonly understood entrance areas. Mailboxes, trip-proof door-mats and proper entrance lighting are relevant here. Even if an object like a mailbox doesn't have a real function, it can still create a powerful perception in residents by being part of a daily routine, such as checking the mailbox for today's care home menu. Boundaries can also be strengthened by protocols that require residents to enter other people's rooms by knocking or requesting permission for entry first.

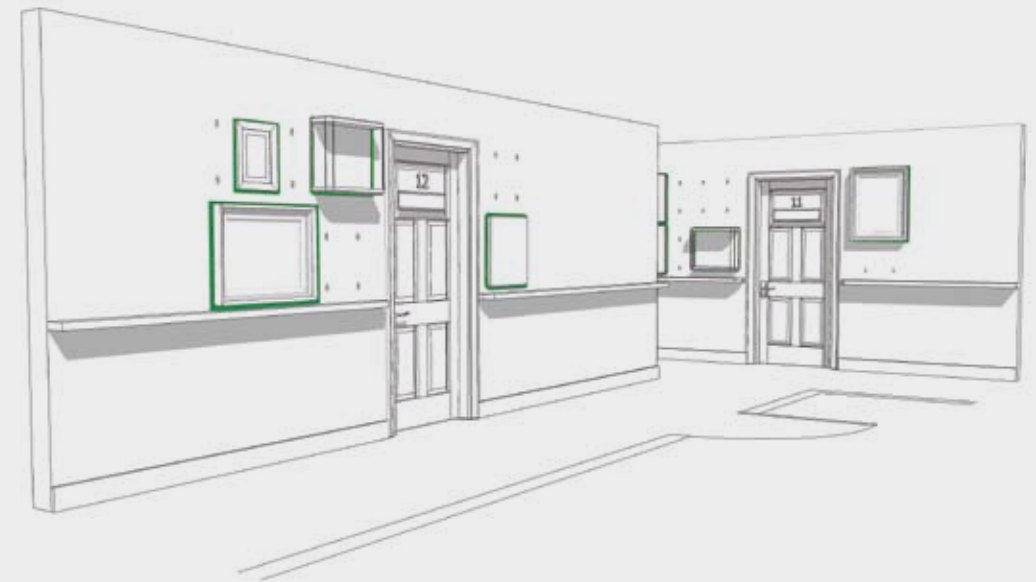

BEDROOM ENTRANCE

– Personalised wall space within communal corridors (in green).

---

### The Front Door

The door currently marks biggest boundary between private and communal space. But it can be improved by creating a language reminiscent of 'front doors', so that residents understand that this is not a door to another room but a door to another home. This can be done by using old-style doors in a different style to internal doors within the care facility. Ideally the door should look like it is made of solid wood, with appropriate detailing and a 'front door' handle.

The modular retail display system used for customising the interior of the bedroom can also be introduced into the hallway outside the room to create more expansive personalisation opportunities than a traditional memory box could offer. Colour panels could create a unique area of colour alongside individual picture frames showing personal memories, small acrylic boxes holding possessions of personal importance, and even small wall-mounted potted plants.

Creating a personalised entrance area to the bedroom can help improve a resident's ability to distinguish between their own space and someone else's, enhance wayfinding ability throughout the home for everyone by providing more identifiable landmarks, and create better communication tools for carers to engage in conversation with residents.

---

# DRESSING



An existing bedroom interior

## DRESSING

Dressing is an intensely private experience. As dementia progresses, a person's cognitive and physical abilities decline to the point at which they must accept assistance for others, dress in the presence of another person, or even have a carer dress them. This process can be stressful and frustrating. Numerous care strategies have been developed to help people adjust to the new realities of assistance with dressing. But relatively little attention has been given to the design of the environment or products that a carer uses to perform this assistance, resulting in a make do approach by both carers and residents.

Wellbeing and self-esteem are linked to personal appearance. In short, looking good can help you feel good and retaining one's identity through appearance can be a positive experience for a resident as well as portraying a positive image to others. Dressing is a fundamental activity of daily living and the gradual loss of this ability by care residents can be very stressful and frightening.

### Enabling Interventions

Many person-centred care strategies have been developed so carers and family can assist a person only when necessary and in such a manner that helps alleviate any frustrations and fears. The majority of these strategies are based around a resident having choice and making decisions – although choice is usually limited – and by making a remote assessment of abilities so as not to over-assist.

Inappropriately designed and specified furniture can lead to a person requiring unnecessary assistance in situations where better support mechanisms could extend independence. The aim should be to maximise a resident's abilities so the requirement for external support is kept to a minimum. Take for example, access to low drawers. One person interviewed with early stage dementia was unable to reach or bend over to the lower

drawers in his bedroom cabinet. It took him time and patience to open the drawers by hooking his walking stick through but eventually he was able to do so. For a person with similar physical capabilities but more advanced dementia, this would not be possible. Conceptually it would be too difficult a process to connect the walking stick with opening a drawer.

Simple enabling interventions, as seen in one care facility, held some surprising results. Residents were actively involved in the dressing cycle, a strategy that proved beneficial by giving them purpose. Washing baskets were introduced into their rooms and some took pride in being part of a daily routine and assuming responsibility for their lives. Some people with dementia are incontinent, feel ashamed and hide the dirty sheets and clothing rather than face up to the embarrassment. The provision of a washing basket meant that they could put their sheets and clothes into the basket themselves without embarrassment.

Staff in this care facility would collect the washing and, where necessary, collect any clothes that needed washing that weren't in the basket. Assistance with dressing was transformed into a positive activity for residents, contributing to their self-image and sense of purpose.

Guided by research into dementia, much current furniture for dementia care has been designed within certain aesthetic guidelines that aim to prompt a person's memories and help care residents remember what an object is and what it does. The use of aesthetics to help recollect functions is a valuable tool, but it can also be very limiting.

Where designers and manufacturers attempt to combine new dementia-friendly features into older-style furniture, both innovations in usability and the aesthetics of reminiscence can be compromised. Styles change, so it is important that innovations and aesthetics are mutually supportive in

any furniture design. The following concepts are therefore based on a combination of person-centred care and environmental psychology theory to assist people in recognition of function and enable ability.

### Designing for Ability

Assuming no external medical influences such as a fall, the increase in assistance required by a care resident in their daily dressing routine is gradual, but over time this can transform radically. Difficulties begin with small physical restrictions like impaired dexterity from arthritis, meaning problems with those tough top buttons or being unable to stretch far enough to put a sock on. Dementia is not a factor in this. However as dementia progresses, a person's normal level of cognition is affected. Symptoms such as dressing apraxia begin to impair a person's ability so that they forget the sequence of how to dress. A resident may attempt to put their legs through arm-holes in a cardigan or attempt to put a bra on over a blouse.

When these things happen, a lot of frustration may occur whatever the care scenario. Without assistance, a person may recognise that something is wrong but may not know exactly what. With assistance, residents may find it difficult being told what to do. In the later stages of dementia, a person may lose the ability to physically take part in the process of dressing. However the resident should always be consulted and, where possible, given some choice in what they would like to wear.

To cater for the wide range of abilities in a care home, there is a correspondingly wide array of product support. However, just as frustrations can occur if a carer over-assists, there can also be problems with an over assisting product. It is important that design for dementia recognises a range of abilities and avoids stigmatising people unnecessarily. Two products involved in dressing have been developed as a result of our research for the purposes of showing different examples of

how improvements could be made to care furniture. A key aspect of their development is that they are inclusive of people and not self-evidently aimed at dementia care. Features that improve quality of life for residents should be able to be viewed as aesthetic design features rather than assistive technology.

## WARDROBE

The wardrobe is the hub for dressing and should provide care and support for longevity of use at every stage of dementia.

### 1. Height Reduction and Access

According to research by Renray Healthcare, the average height of a person in care is 5ft 3 ins. This makes traditional wardrobe heights inaccessible, a state of affairs compounded by age-related stiffness and other physical ailments. A significant proportion of residents will also be in a wheelchair at some point. Full-height wardrobes contain many inaccessible features based purely on the height. Lower areas can be just as inaccessible for older people. The wardrobe has been split into daily use (the doors) and seasonal use (the bottom drawers). The latter is explained further below.

### 2. Colour and Material

A combination of two contrasting materials helps those with sight problems to understand where to interact with the product. Use of good quality hardwood laminates creates variations in surface texture; they are also hygienic, easy to maintain.

### 3. Oversized Handles

The oversized handle is a good example of the chosen aesthetic, its size and prominence suggesting its function. Heavily contrasted against the white background, the handle is easily visible for those with sight loss. Reaching from top to bottom allows both taller residents and those in wheelchairs the same access point. As the one main point of interaction, the handle is made of hardwood to achieve a quality feel.

### 4. Content Visible Drawers

Signs on drawers are evident in current homes and offer many benefits, even though residents, family members and carers suggested that this approach might be stigmatising. A new drawer front, which shows the drawer's contents whilst remaining as similar to a standard drawer design as possible, gives the person cues to the whereabouts of specific items of clothing while making the signage redundant.

### 5. Personalisation

Personalisation should exist in as many places as possible to give comfort, enable communication and assist in identifying ownership. Having pictures of loved ones, hobbies and other topics relating to a person's personal history placed on the wardrobe will help residents recognise that the possessions they are interacting with are their own.

### 6. Out-of-season storage

It is important not to confuse residents with too many clothing choices. In this wardrobe, summer and winter clothing areas have been separated to reduce choice. Out-of-season clothes are able to be stored on site by designing the drawers to be naturally inaccessible for residents. Placing the drawers low, to the back and with no environmental cues as to operation, limits access without the need for a lock or to store them in an offsite location.

### 7. Low-tech Illumination

Illumination is important because it assists the older eye to see better. It also highlights areas of interaction by providing better contrast. This is an area of focus for some wardrobe developments for dementia and is usually met by an electric-powered light to intensify the light. Low-tech solutions should be used wherever possible to cut down on cost and maintenance. Here, the design allows environmental light to penetrate the wardrobe more deeply.

### 8. Clothes Display Hangers

Specialised hangers have been developed so that whole outfits can be stored on one hanger. The design is different from traditional hangers by allowing hangers to be hung off one another. Hanging complete outfits together makes storage and selection of clothing easier for residents and carers alike, and enables residents to recognise and choose an outfit for themselves.

### 9. Clothing Display Hook

When the time comes that a person needs assistance in dressing, it is good care practice to give the resident two choices. Carers currently lay clothes out on a bed for residents to make a decision. A carer can now hang two options on display hooks in combination with the specialised hangers on the white background of the front doors. This enables the resident to see how the clothes would look in a vertical layout and at the right scale without the need to conceptualise clothes stacked on a bed. Clothes hanging up in a ready-to-wear format may help a resident in an advanced-stage of dementia anticipate the activity that is about to take place.

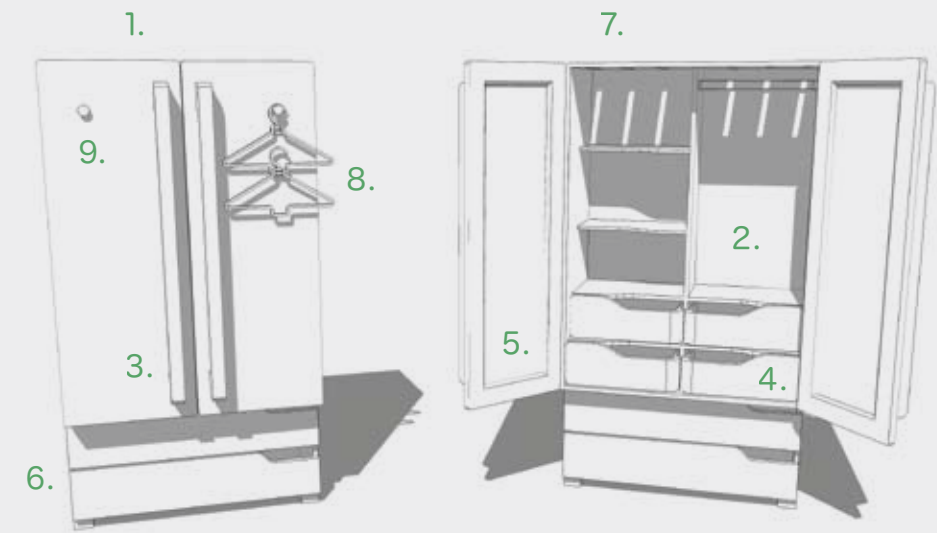

#### WARDROBE

- 1. Height Reduction and Access
- 2. Colour and Material
- 3. Oversized Handles
- 4. Content Visible Drawers
- 5. Personalisation Area inside door
- 6. Out of Season Storage
- 7. Low-tech Illumination
- 8. Clothing Display Hanger
- 9. Clothing Display Hook

within communal corridors  
Personalised wall space  
—  
BEDROOM ENTRANCE



Wardrobe designed to assist people of different abilities in the process of dressing

## DRESSER

Other bedroom furniture can benefit from many of the innovations developed for the wardrobe while connecting aesthetically to create a consistent range of products within a room. The dresser concept uses the same colour variants so as to provide similar benefits for those with visual impairments. It is made with the same materials and its drawers are given the same treatment, so all the relevant innovations remain.

New innovations are required for dresser design and these relate mainly to mobility. Two types of people living with dementia require use of a dresser: those fully mobile sitting in a chair, and those less mobile using a wheelchair. Residents placed in a normal chair sit lower than wheelchair users who must keep their feet off the ground, so ideally the dresser should be height adjustable. This, however, would be prohibitively expensive if addressed through mechanical means.

The low-tech concept here has a number of feet (highlighted in white) that range in size and can be affixed using friction to the dresser in order to maximise usability for all people with dementia.

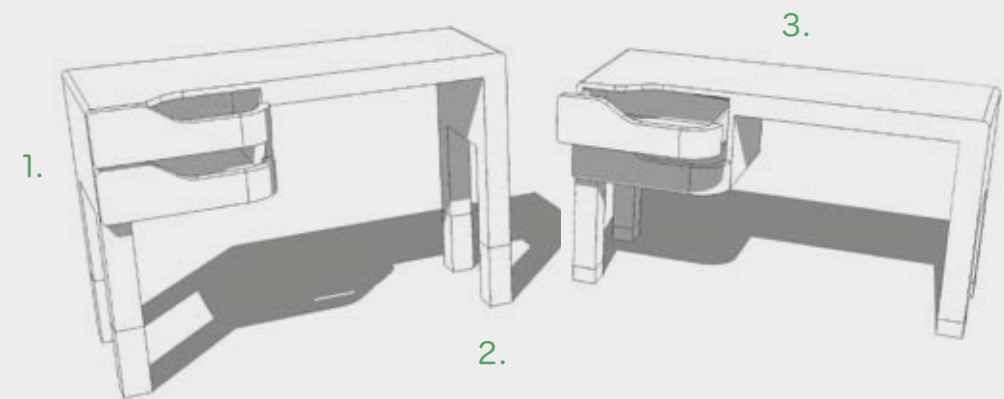

### DRESSER

- 
- 1. Content Visible Drawers
- 2. Low Tech Height Adjustment
- 3. Colour and Material



Dresser designed to assist people of different abilities in the process of dressing



---

# CONCLUSION

---

---

## CONCLUSION

In this publication we have explored how design can be used to improve existing care home environments for people with dementia. We have offered insights and new design concepts for retrofit products and facilities to enable residents to capitalise on their existing abilities.

Through a combination of empowering residents and including amenities for the running of familiar activities we have sought to demonstrate how basic design changes can help promote independence and more meaningful interaction between staff and residents, enhancing care and improving quality of life.

In the dining section, the ritual of eating has been explored and design outcomes generated which work in line with current food management structures. Guidance for the interior layout of dining areas suggests how leaning surfaces and the reduction of visual barriers can promote safe and free movement for residents of all abilities throughout shared space.

The integration of safe kitchen areas into the heart of dining spaces illustrates how redundant space can be used between mealtimes to run activities while also providing important sensory cues during meals to help create a more coherent and meaningful eating experience.

Garden areas, tables and new light fittings have been proposed to ensure all social spaces within the home are accessible and enjoyable for residents with all levels of physical, visual and cognitive ability. An entire tableware range has been developed and tested with users to promote independent eating and improve the experience of being fed for those who are no longer able to feed themselves.

The bedroom section has focused on the importance of personalising private space and on enabling residents to retain independence for as long as possible. Furniture (including a wardrobe and dresser) has been developed with design features that respond to the needs of care home residents with dementia. Retail sector display techniques have been applied to create a low-cost, low-maintenance system that attends to individual needs and desires while creating an important differentiation between private and communal space.

We strongly advocate this approach to customisation as we know that redecoration and building works in care homes can be enormously disruptive and costly, and wasteful of staff time. Creating a simple, easy way to customise a bedroom enhances care without compromising operational efficiency. This principle applies more generally to all the design proposals that we have made in this publication.

By extending the research process to building physical prototypes, we have sought to make suggested design changes more real and tangible and within the reach of care home providers. We hope that what we have proposed acts as an encouragement to further research and development in this area in order to provide the type of care home environment that people with dementia deserve.

## SELECTED REFERENCES

**Baucom A H,**  
*Hospitality Design for the*  
*Graying Generation,*  
John Wiley & Sons, 1996

**Bell P A, Greene T C,**  
**Fisher J D, Baum A,**  
*Environmental Psychology,*  
Harcourt Brace College  
Publishers, 1996

**Berg G,**  
*The Importance of Food and*  
*Mealtimes in Dementia Care,*  
Athenaeum Press, 2002

**Brush J A, Calkins MP,**  
*Design for Dining, Building Ideas,*  
Alzheimer's Care Quarterly,  
January – March, 2003

**Kaplan S, Kaplan R,**  
*Cognition and Environment:*  
*Functioning in an Uncertain World,*  
Praeger, 1982

**Kitwood T,**  
*Dementia Reconsidered:*  
*The Person Comes First,*  
Open University Press, 1997

**Marshall M,**  
*Food Glorious Food,*  
Hawker Publications, 2003

**Philips L R, Van Ort S,**  
*Measurement of Mealtime*  
*Interactions among Persons*  
*with Dementing Disorders,*  
Journal of Nursing Measurement,  
1993, p41-55

**Sharp S,**  
*Home from Home: A Report*  
*Highlighting Opportunities for*  
*Improving Standards of Dementia*  
*Care in Care homes,*  
Alzheimer's Society, 2007

**Stokes G,**  
*And Still the Music Plays:*  
*Stories of People with Dementia,*  
Hawker Publications, 2008

**Stokes G,**  
*Challenging Behavior in dementia:*  
*A person centred Approach,*  
Speechmark Publishing, 2000

**Zeisel J,**  
*I'm Still Here:*  
*A Breakthrough Approach to*  
*Understanding Someone Living*  
*with Alzheimer's,*  
Avery, 2009

**Zeisel J, Hyde J,**  
**Levkoff S,**  
*Best Practices: An Environmental*  
*/ Behavior (E/B) Model for*  
*Alzheimer Special Care Units,*  
Journal of Alzheimer's Disease,  
March – April, Volume 9,  
Number 2, 1994

## ABOUT THE AUTHORS

### Gregor Timlin

–

Ireland's Gregor Timlin studied Furniture Design at the Dublin Institute of Technology where he was awarded the DIT Gold Medal for Academic Achievement. He has since completed a Masters degree in the Design Products Department at the Royal College of Art in 2008. His commitment to a people-centred approach in his design work led to taking on this challenge of researching design for dementia care at the Helen Hamlyn Centre.

### Nic Rysenbry

–

Immediately after completing his Bachelors in Industrial Design in New Zealand, Nic moved to London to gain global experience in design. Having gained extensive experience in the retail design sector, he went back to study for a Masters degree in the Royal College of Art Design Products department. He joined the Helen Hamlyn Centre in 2009 to develop his interests in socially inclusive design.

## PARTNER DESCRIPTION



### Bupa

–

Bupa's Care Homes provide some 35,000 beds principally in the UK but also in Spain, New Zealand and Australia for older people in need of care and refuge. Bupa endeavours to provide the highest possible standards of care in all its markets and its collaboration with the RCA and the Helen Hamlyn Foundation are a reflection of its commitment to provide a leadership in the design and provision of dementia care, perhaps the greatest health and social care challenge affecting ageing populations

[www.bupa.co.uk](http://www.bupa.co.uk)



### Helen Hamlyn Centre

–

The Royal College of Art Helen Hamlyn Centre provides a focus for people-centred design and innovation at the RCA in London, the world's only wholly postgraduate university institution of art and design. Its multi-disciplinary team of designers, engineers, architects, anthropologists and communication experts undertake practical research and projects with industry to advance an approach to design that is socially inclusive. Its Research Associates programme teams new Royal College of Art graduates with industry partners.

[www.hhc.rca.ac.uk](http://www.hhc.rca.ac.uk)

## Acknowledgements

–

The authors would like to thank the following people for their help and support during the project:

Clive Bowman, Medical Director of Bupa Care Services, Dan Locking and Kirsty Wilson of the Bupa Service Development Team, Carol Purdy and all her staff at St. Georges care home in Surrey, Michalae Thompson and her staff at Mead bank nursing home in London, Nada Savitch of Innovations in Dementia and the staff and clients of Swindon Forget Me Not Center.

A special thanks to all those who allowed us to visit their homes and offer us insight into their lives.

Design for Dementia: Improving dining and bedroom environments in care homes

© 2010 Helen Hamlyn Centre,  
Royal College of Art  
ISBN 978-1-907342-27-1

British Library Cataloguing-in-Publication Data:  
A catalogue record for this book is available from the British Library. All rights reserved. No part of this publication may be reproduced, stored in a retrieval system or transmitted in any form or by any means, electronic, mechanical, photocopying, recording or otherwise, without the prior consent of the publishers.

Published by:  
Helen Hamlyn Centre, Royal College of Art  
Kensington Gore  
London SW7 2EU  
+44 (0)20 7590 4242  
hhc@rca.ac.uk  
www.hhc.rca.ac.uk

Authors: Gregor Timlin and Nic Rysenbry  
gregor.timlin@network.rca.ac.uk  
nic@nicrysenbry.co.uk  
Editors: Rama Gheerawo and Jeremy Myerson  
Design / Art Direction: Luke Gould and Ray O'Meara  
Photography: Luke Gould and Steven Emmanuel  
Printed by Calverts

---

---

---